

**NISO
NIS
NISF**

50Hz

End Suction Centrifugal Pump



REPRESENTATIVE IN GEORGIA

Address: Tbilisi; Libani street 2

Tel: +995 032 248 35 62

Email: info@cnp.ge

Website: cnp.ge



E190701
Code1500067430
subject to amendments



Pumping Water Pumping Honor

Stock code:300145



PUMPINGS.STORE : 096-385-8065



Company profile

Founded in 1991, Nanfang Zhongjin Environment Co.,Ltd. (hereinafter referred to as CNP) has been listed on the Shenzhen Stock Exchange on 9th December 2010; Stock name: CNP; Stock code: 300145.

As the first enterprise specializing in the research and large-scale production of stainless steel stamping welded centrifugal pump in China, CNP is currently the professional manufacturer with the highest volume of production and marketing in that industry. It ranks first in the country in terms of product scope, sales volume, and production quality. The company has set up a complete network of marketing services to meet the requirements of overseas markets as well as domestic needs. The products have seen a wide range of application in the area of pressurization, industry, living water, cycling of air-conditioning water, heat supply, fire extinguishing system, pumping of underground water, treatment of sewage and waste water, chemical industry and desalination of sea water etc.

CNP has now entered into the fast track of development and has taken a major step forward in forging China Strong Pump Enterprise and World's famous brand in the Pump Industry. In order to better meet the client's needs and requirements for expansion, it has set up a wide network of selling and service, as well as offices and service centers in major cities in China, which are aimed at providing timely and effective services for our clients. Meanwhile, our company has successfully penetrated into the world market by forging a good business relationship with more than 50 countries and regions in the Europe, Northern American, and Southeast Asia etc.

Contents

Model definition	1
Min. inlet pressure	2
Applications	3
Product structure	3
Features	3
Performance parameters	3
Curve conditions	3
Working conditions	4
Motor parameters	4
Pipeline Installation requirements	4
Spectral spectrum	5
Sectional drawing	7
Material list	7
NIS*G,NIS*(Q) Product range	9
NIS*G,NIS*(Q) Performance scope	12
2-Pole	
NIS100-65-200G/100-65-250G Performance curve	12
NIS100-65-315G/100-80-160G Performance curve	13
NIS125-100-200(Q)/125-100-200G Performance curve	14
NIS125-100-250G/125-100-315G Performance curve	15
4-Pole	
NIS100-65-200G/100-65-250G Performance curve	16
NIS100-65-315G/100-80-160G Performance curve	17
NIS125-100-200G/125-100-250G Performance curve	18
NIS125-100-315G/125-100-400G Performance curve	19
NIS150-125-200(Q)/150-125-200G Performance curve	20
NIS150-125-250G/150-125-315(Q) Performance curve	21
NIS150-125-315G/150-125-400(Q) Performance curve	22
NIS150-125-400G/200-150-250(Q) Performance curve	23
NIS200-150-250G/200-150-315G Performance curve	24
NIS200-150-400G Performance curve	25
NIS*G,NIS*(Q) Dimension drawing	26
NIS*G,NIS*(Q) Dimension table	26
NIS*G,NIS*(Q) Flange	28
NISO,NIS,NISF Product range	29
NISO,NIS,NISF Performance curve	34

Contents

2-Pole	
NISO,NIS,NISF50-32-160/50-32-200 Performance curve	34
NISO,NIS,NISF65-40-200/65-40-250 Performance curve	35
NISO,NIS,NISF65-40-315/65-50-160 Performance curve	36
NISO,NIS,NISF80-50-200/80-50-250 Performance curve	37
NISO,NIS,NISF80-50-315/80-65-160 Performance curve	38
NISO,NIS,NISF100-65-200/100-65-250 Performance curve	39
NISO,NIS,NISF100-65-315/100-80-160 Performance curve	40
NISO,NIS,NISF125-100-200/125-100-250 Performance curve	41
NISO,NIS,NISF125-100-315 Performance curve	42
4-Pole	
NISO,NIS,NISF50-32-160 Performance curve	42
NISO,NIS,NISF50-32-200/65-40-200 Performance curve	43
NISO,NIS,NISF65-40-250/65-40-315 Performance curve	44
NISO,NIS,NISF65-50-160/80-50-200 Performance curve	45
NISO,NIS,NISF80-50-250/80-50-315 Performance curve	46
NISO,NIS,NISF80-65-160/100-65-200 Performance curve	47
NISO,NIS,NISF100-65-250/100-65-315 Performance curve	48
NISO,NIS,NISF100-80-160/125-100-200 Performance curve	49
NISO,NIS,NISF125-100-250/125-100-315 Performance curve	50
NISO,NIS,NISF125-80-400/125-100-400 Performance curve	51
NISO,NIS,NISF150-125-250/150-125-315 Performance curve	52
NISO,NIS,NISF150-125-400/200-150-315 Performance curve	53
NISO,NIS,NISF200-150-400/250-200-315 Performance curve	54
NISO,NIS,NISF250-200-400/300-250-315(Q) Performance curve	55
NISO,NIS,NISF300-250-400(Q)/300-250-315 Performance curve	56
NISO,NIS,NISF300-250-400 Performance curve	57
NISO Dimension drawing	58
NISO Dimension table	59
NISO Performance curve	61
NISO Dimension table	61
NIS,NISF Product range	67
NIS,NISF Performance curve	67

Model definition

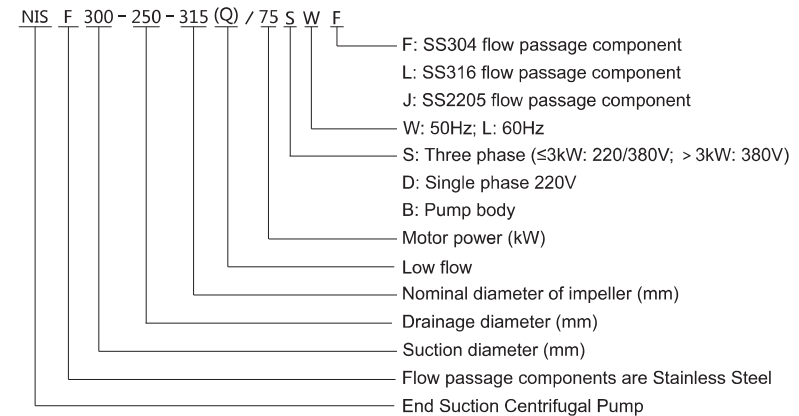
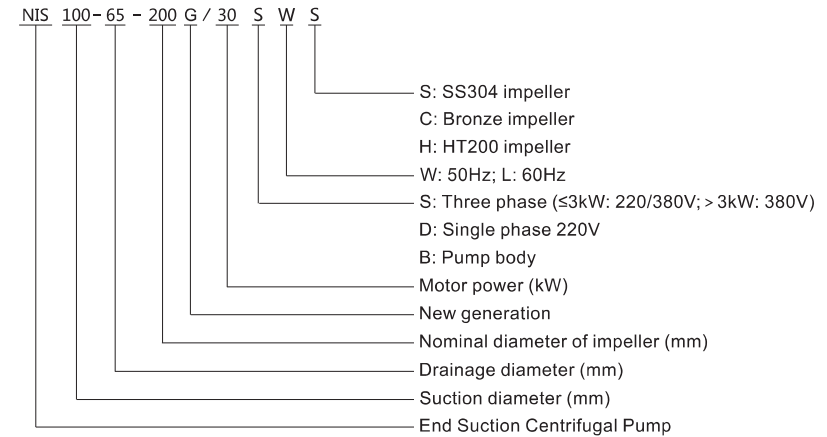

Model definition

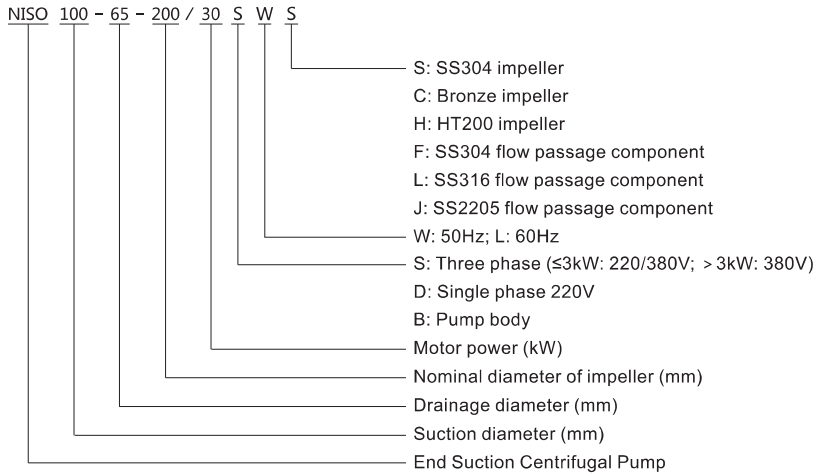

Minimum inlet pressure NPSH

In case that the pressure in pump is lower than the steam pressure used to convey liquid, the cavitations will occur. To avoid cavitations, a minimum pressure at the inlet side of the pump shall be guaranteed. The maximum suction can be calculated with the following formula:

$$H = P_b \times 10.2 - NPSH - H_f - H_v - H_s$$

H—Maximum suction head(m)

P_b —Atmosphere pressure(bar)

In a closed system, P_b means system pressure(bar)

NPSH—Net positive suction head(m)

It can be read from the point of Max. flow rate shown on NPSH curve.

H_f —Pipeline loss at the inlet(m)

It is in accordance with the pipeline possible Max. flow.

H_v —Steam pressure(m)

It depends on liquid temperature and steam pressure value.

H_s —Safety margin(m)

Minimum 0.5m delivery head.

If the calculated result H is negative, the pump may run under the Max. suction head H. In case the calculated result H is negative, a delivery head of Min. inlet pressure is necessary.

NOTE: Normally, the above calculation will not be done.

H is calculated in the following conditions:

1. The liquid temperature is comparatively higher;
2. Liquid flow exceeds rated value;
3. Suction head is comparatively large or inlet pipeline long;
4. System pressure is too low;
5. Bad inlet condition.

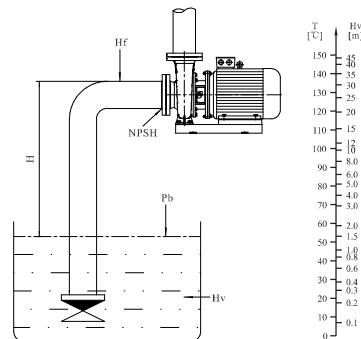

Applications

- Clean, thin, non-corrosive, non-flammable or non-explosive liquid without grain or fiber.
- Water supply system
- HVAC system
- Booster and constant water supply system
- Fire-fighting and splitting system
- Irrigation and farming
- Industrial cooling and heat circulation system
- Industrial transferring and drainage system

Product structure

- Non-self-priming, single stage, single suction, horizontal axial suction and radical discharge, pump body is fixed by base.
- Standard wear-resistant mechanical seal.
- TEFC motor, size complies to IEC standard.
- NISO pump use bearing cradle, which can orientate bearing, prevent from radical vibration, improve the rigidity of rotary part.
- NISO pump integral pump shaft, use deep groove grease lubricated bearing.
- NISO pump use semi-flexible coupling to connect pump and motor.
- NISO pump dimension conforms to ISO2858 standard.
- NIS, NISF series pump are coupled with extension shaft structure.
- Inlet and outlet flange and pump body of cast iron pump conform to standard of PN16 in GB/T17241.6 (ISO7005-2); Inlet and outlet flange and pump body of Stainless Steel pump conform to standard of PN16 in GB/T9113 (ISO7005-1).

Performance parameters

- Max. Flow: 1200 m³/h
- Max. Head: 160 m
- Max. Working pressure: 16 bar
- Max. Inlet pressure: 6 bar
- Max. Power: 200kW
- Liquid temperature: -15°C~ 110°C
- Inlet and outlet diameter:
 - Inlet diameter: DN50~DN300
 - Outlet diameter: DN32~DN250

Features

- Adopt Pull-back structure, avoid dismantling pump body and pipeline when repairing.
- All NISO pump only use 4 types of pump shafts and bearing cover, making many parts exchangeable.
- Designs of NIS, NISO, NISF series impellers are optimized, inlet is enlarged, no whirlpool, deduct water pump NPSH efficiently, which makes pump work stable with little noise. Performance curve is flat, flow range is wide, performance is similar with international pump industry peers.
- NIS*G, NIS*(Q) series pump are designed according to newest standard in GB/T5662, whose performance curve are steeper than NIS, NISO, NISF series. Flow range conforms to requirements, use excellent hydraulic model and CFD optimization, high efficiency, reasonable head spread, compact structure, easy maintenance.
- NIS, NISF pumps are small, compact and easy to install.
- Main spare parts like impeller, pump body, pump head of NIS*G, NIS*(Q) series pump are cast iron. But can be customized according to customers' requirement.

Curve conditions

- Following conditions are suitable for the performance curves shown above.
- All curves are based on the measured values of motor 3×380V. 50Hz: under the constant speed of 2900 rpm, 1450rpm or 1480rpm; 60Hz: under the constant speed of 3500rpm, 1750rpm.
- Curve tolerance in conformity with ISO9906:2012, Grade 3B.
- Measurement is done with 20°C air-free water, without impurities.
- The operation of pump shall refer to the performance region indicated by the thickened curve to prevent overheating due to too small flow rate or overload of motor due to too large flow rate.
- If the thickness and density of the pumped liquid is different from water, the motor power should be adjusted.

Working conditions

Relative humidity of pump

- The pump is specifically designed for installation in non-corrosive and non-explosive environments with a relative humidity of no more than 95%.

Ambient humidity and altitude

- Ambient humidity and installation altitude are important factors influencing motor service life as they also affect the life of bearings and insulation systems.

- The installation altitude is the height at which the installation location is above sea level. If the ambient temperature exceeds the recommended maximum value, or if the installation height exceeds the recommended maximum altitude, air cooling effect may be poor due to low density and the motor shall not be operated at full capacity. In this case, choose a motor with a higher output power.

Motor parameter

Standard motor

- TEFC motor, size complies to GB/28575 standard.
- Standard configuration: 2-pole motor and 4-pole motor.

Pipeline Installation requirements

- Pump casing must not be subjected to pipe pressure when installing the pipe.

- The suction and drain pipes must be sized appropriately and the inlet pressure of the pump needs to be considered.

- Install the pipe to avoid air blockage, especially on the inlet side of the pump. See picture below.

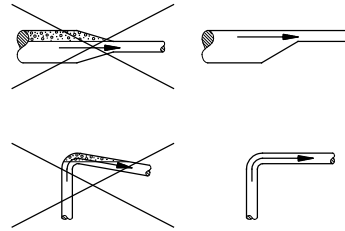

- Install an isolation valve on each end of the pump so that the system does not have to be drained when cleaning or repairing the pump.

- Ensure that the pipe is sufficiently supported (inlet and outlet side) as close as possible to the pump. The butt flange should be attached to pump flange without being subjected to tensile stresses, as the presence of tensile stress can damage the pump.

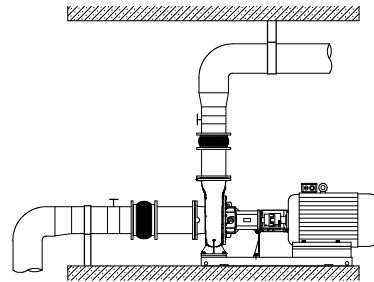

NIS*G,NIS*(Q) Spectral spectrum

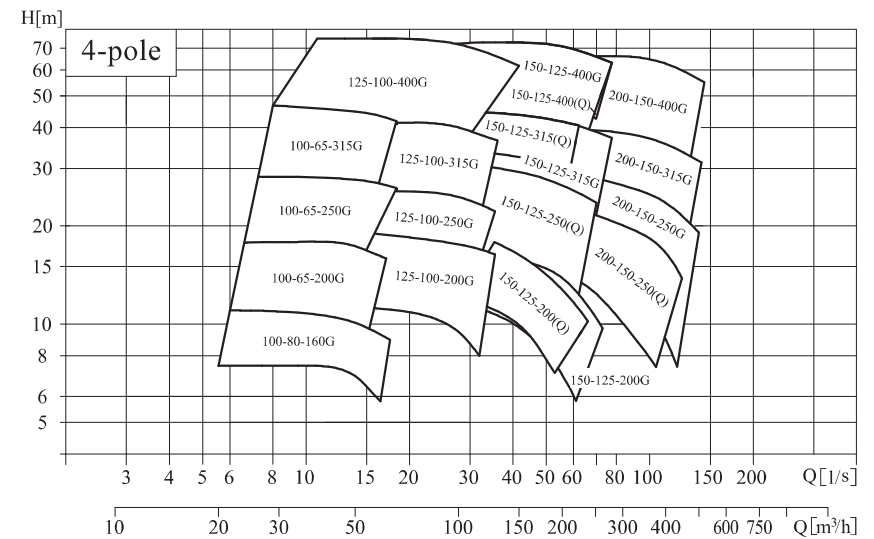
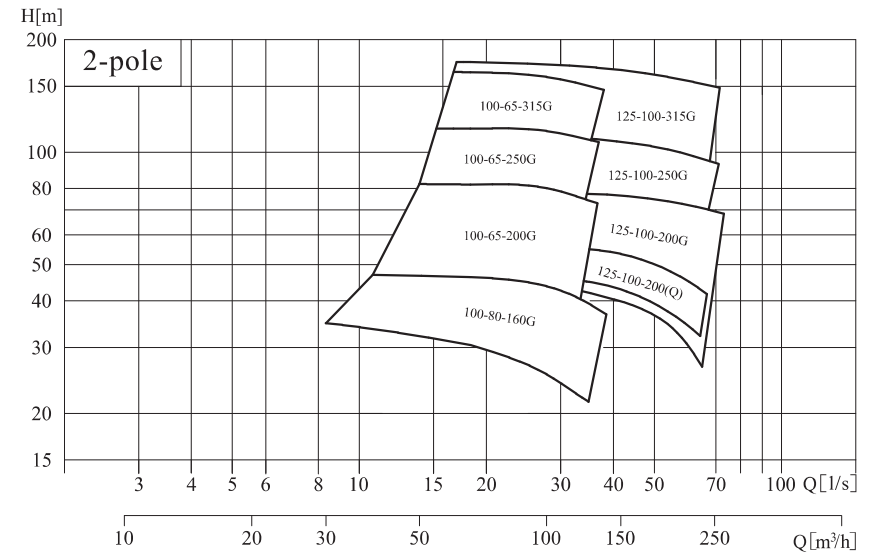

NISO,NIS,NISF Spectral spectrum

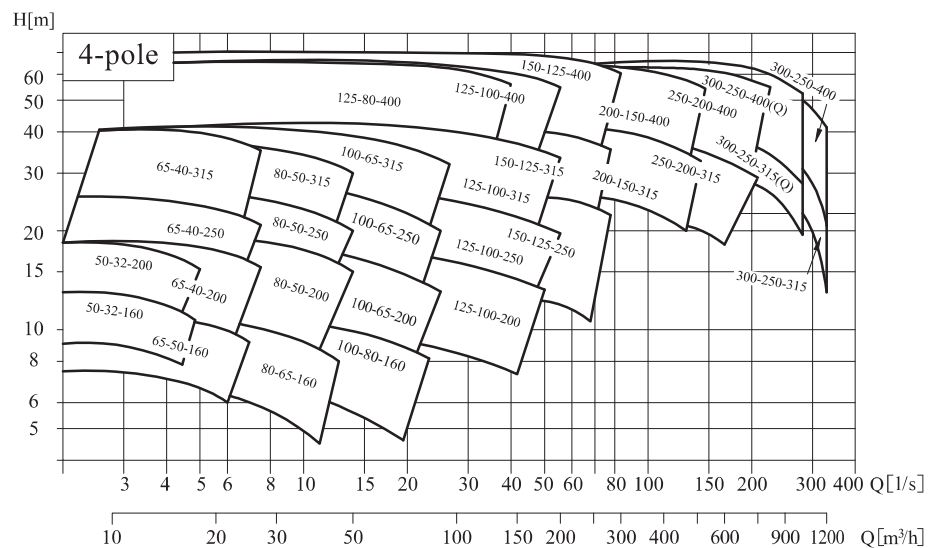
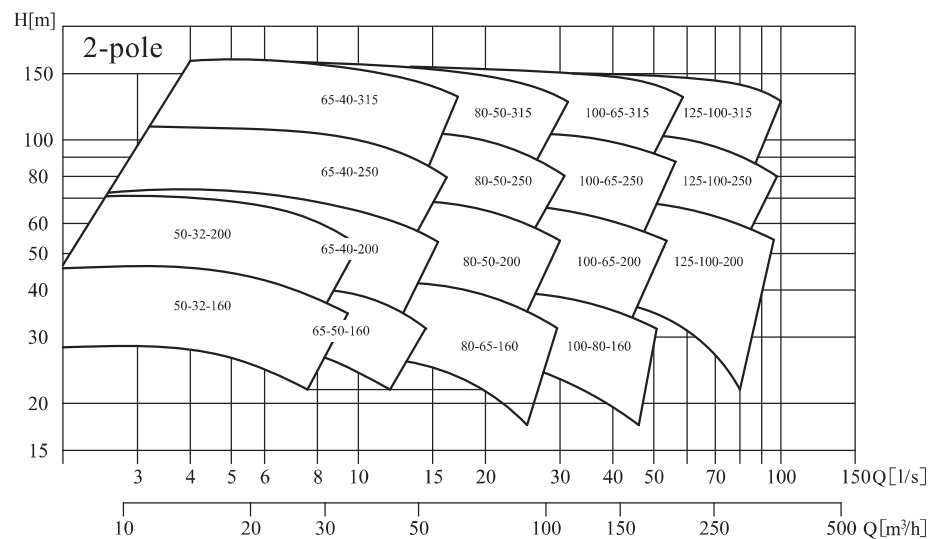

NIS,NISF Sectional drawing

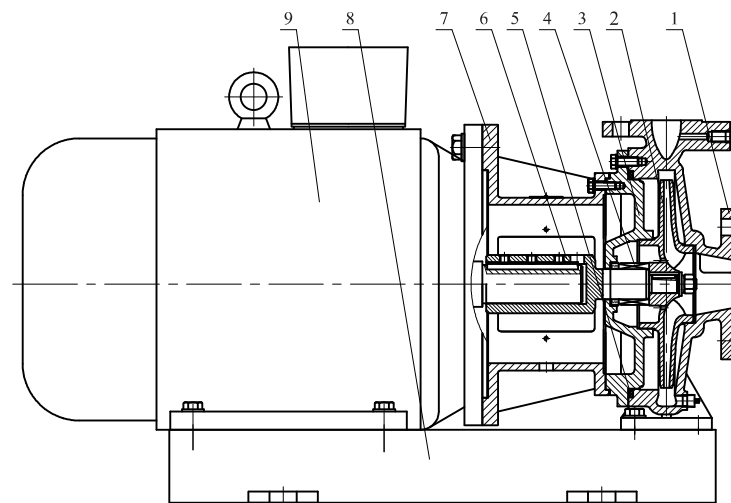

Material list of NIS,NISF

No.	Parts	Material	Code/AISI/ASTM
1	Pump body	QT500-7/ZG07Cr19Ni9	ASTM80-55/AISI304
2	Impeller	HT200/ZG07Cr19Ni9	ASTM25B/AISI304
3	Pump cover	HT200/ZG07Cr19Ni9	ASTM25B/AISI304
4	Mechanical seal	Carbon/Silicon Carbide	
5	O-ring	NBR	
6	Shaft	20Cr13/06Cr19Ni10	AISI420/AISI304
7	Pump head	HT200	ASTM25B
8	Base	Q235-A	AISIA570
9	Motor		

Note: Standard material of flow passage components of NIS*G,NIS*(Q) are cast iron, Stainless Steel need to be specially ordered.

NISO Sectional drawing

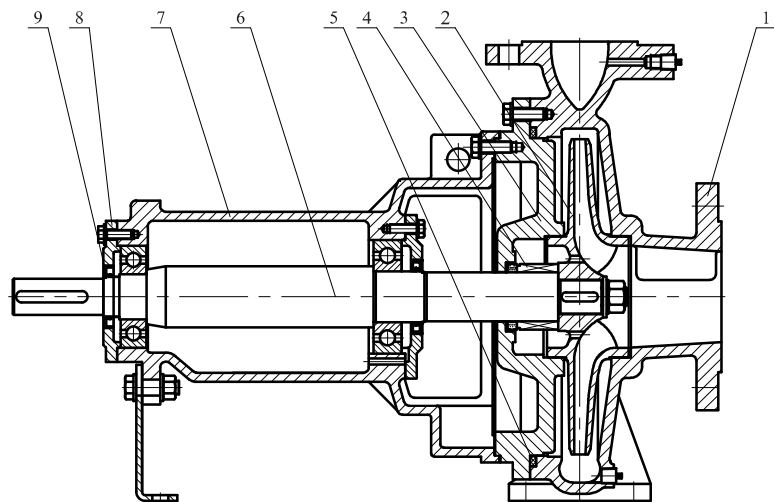

Material list of NISO

No.	Parts	Material	Code/AISI/ASTM
1	Pump body	QT500-7/ZG07Cr19Ni9	ASTM80-55/AISI304
2	Impeller	HT200/ZG07Cr19Ni9	ASTM25B/AISI304
3	Pump cover	HT200/ZG07Cr19Ni9	ASTM25B/AISI304
4	Mechanical seal	Carbon/Silicon Carbide	
5	O-ring	NBR	
6	Shaft	20Cr13/06Cr19Ni10	AISI420/AISI304
7	Bearing housing	HT200	ASTM25B
8	Bearing cover	HT200	ASTM25B
9	Oil seal	NBR	

NIS*G,NIS*(Q) Product range

No.	Model	Q [m³/h]	H [m]	Flow range [r/min]	Motor [kW]	n [r/min]
1	NIS100-65-200G/18.5	100	42	40-120	18.5	2950
2	NIS100-65-200G/22		51		22	
3	NIS100-65-200G/30		67		30	
4	NIS100-65-200G/37		80		37	
5	NIS100-65-250G/45		103		45	
6	NIS100-65-250G/55		116		55	
7	NIS100-65-315G/75		140		75	
8	NIS100-65-315G/90		160		90	
9	NIS100-80-160G/11		26		11	
10	NIS100-80-160G/15	36	15			
11	NIS100-80-160G/18.5	44	18.5			
12	NIS125-100-200(Q)/30	160	43	60-200	30	2950
13	NIS125-100-200(Q)/37		52		37	
14	NIS125-100-200G/30	200	35	80-240	30	
15	NIS125-100-200G/37		45		37	
16	NIS125-100-200G/45		54		45	
17	NIS125-100-200G/55		68		55	
18	NIS125-100-200G/75		74		75	
19	NIS125-100-250G/75		86		75	
20	NIS125-100-250G/90		102		90	
21	NIS125-100-315G/110		128		110	
22	NIS125-100-315G/132		150		132	
23	NIS125-100-315G/160		160		160	

NIS*G,NIS*(Q) Product range

4-pole

No.	Model	Q [m³/h]	H [m]	Flow range [r/min]	Motor [kW]	n [r/min]
1	NIS100-65-200G/3	50	13	20~60	3	1450
2	NIS100-65-200G/4		17.5		4	
3	NIS100-65-250G/5.5		24		5.5	
4	NIS100-65-250G/7.5		28		7.5	
5	NIS100-65-315G/11		40		11	1480
6	NIS100-65-315G/15		45		15	
7	NIS100-80-160G/1.5		7		1.5	
8	NIS100-80-160G/2.2		10		2.2	
9	NIS125-100-200G/4	100	9.5	40~120	4	1450
10	NIS125-100-200G/5.5		13		5.5	
11	NIS125-100-200G/7.5		18		7.5	
12	NIS125-100-250G/11		25		11	
13	NIS125-100-315G/15		33		15	1480
14	NIS125-100-315G/18.5		40		18.5	
15	NIS125-100-400G/30		55		30	
16	NIS125-100-400G/37		68		37	
17	NIS125-100-400G/45	72	45			
18	NIS150-125-200(Q)/5.5	160	8.5	60~200	5.5	1450
19	NIS150-125-200(Q)/7.5		12		7.5	
20	NIS150-125-200(Q)/11		16		11	
21	NIS(F)50-125-200G/5.5	200	7	80~240	5.5	1450
22	NIS(F)50-125-200G/7.5		10		7.5	
23	NIS(F)50-125-200G/11		14		11	
24	NIS150-125-250G/15		18		15	1480
25	NIS150-125-250G/18.5		23		18.5	
26	NIS150-125-250G/22		27		22	

NIS*G,NIS*(Q) Product range

4-pole

No.	Model	Q [m³/h]	H [m]	Flow range [r/min]	Motor [kW]	n [r/min]
27	NIS150-125-315(Q)/22	160	32	60~200	22	1480
28	NIS150-125-315(Q)/30		43		30	
29	NIS150-125-315G/30	200	36	80~240	30	
30	NIS150-125-315G/37		42		37	
31	NIS150-125-400(Q)/37	160	50	60~200	37	
32	NIS150-125-400G/45	200	54	80~240	45	
33	NIS150-125-400G/55		64		55	
34	NIS150-125-400G/75		71		75	
35	NIS200-150-250(Q)/11	300	9.5	120~360	11	
36	NIS200-150-250(Q)/15		12.5		15	
37	NIS200-150-250(Q)/18.5		16		18.5	
38	NIS200-150-250(Q)/22		20		22	
39	NIS(F)200-150-250G/15	400	9	160~480	15	
40	NIS(F)200-150-250G/18.5		12		18.5	
41	NIS(F)200-150-250G/22		15.5		22	
42	NIS(F)200-150-250G/30		20		30	
43	NIS200-150-315G/37		24		37	
44	NIS200-150-315G/45		29		45	
45	NIS200-150-315G/55		36		55	
46	NIS200-150-400G/75		47		75	
47	NIS200-150-400G/90	56	90			
48	NIS200-150-400G/110	63	110			

Performance curve

NIS100-65-200G/100-65-250G

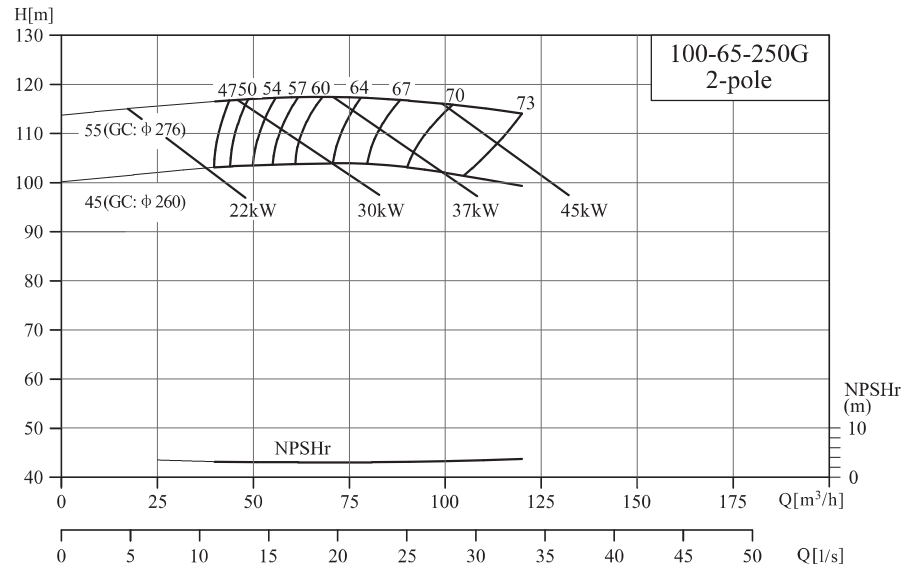
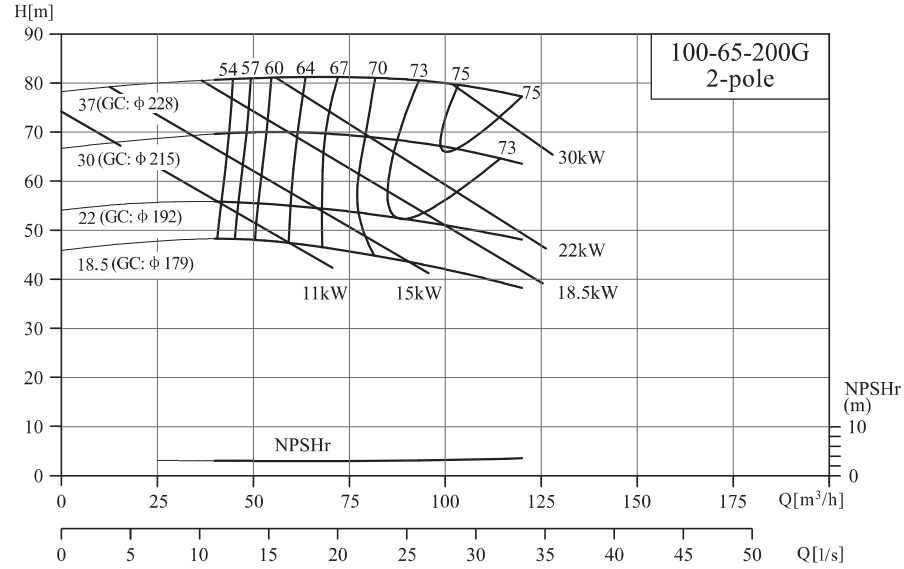

Performance curve

NIS100-65-315G/100-80-160G

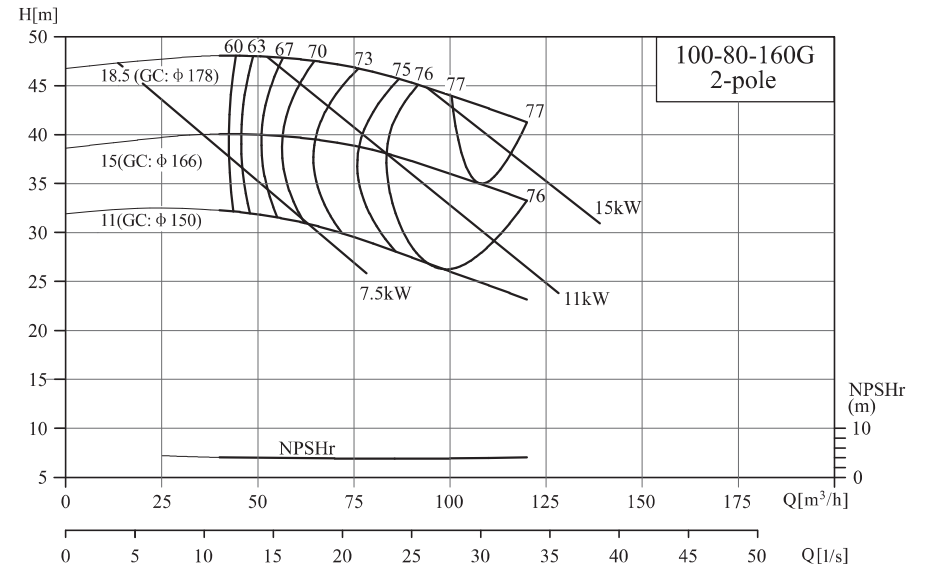
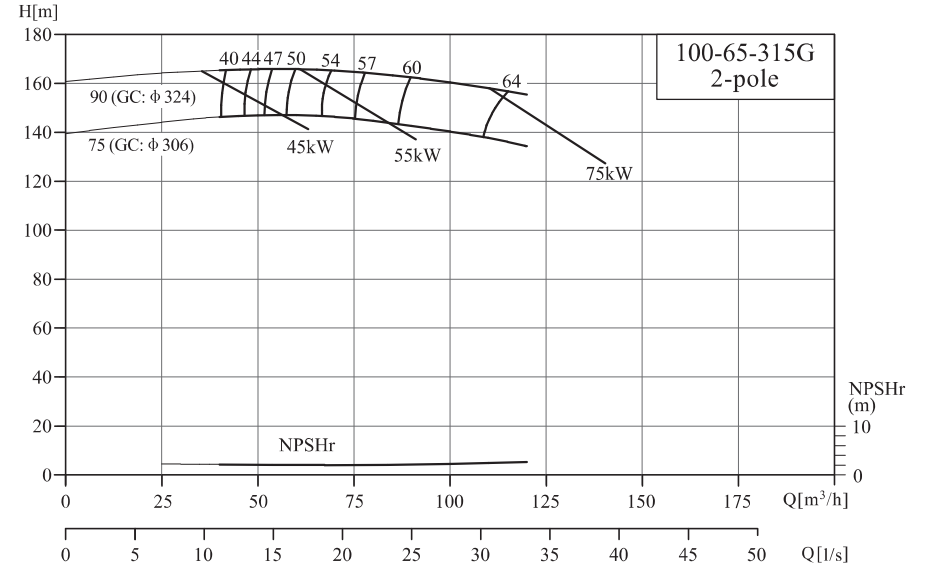

Performance curve

NIS125-100-200(Q)/125-100-200G

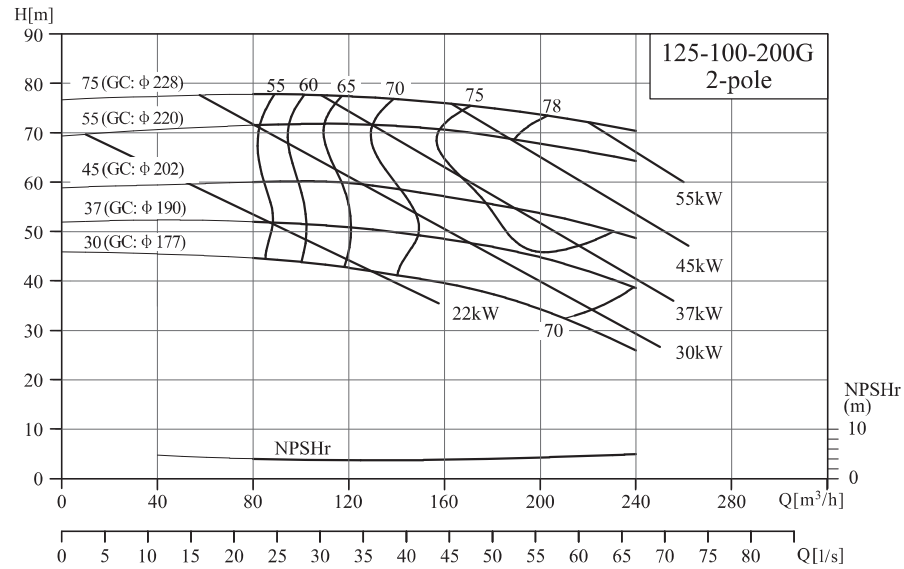
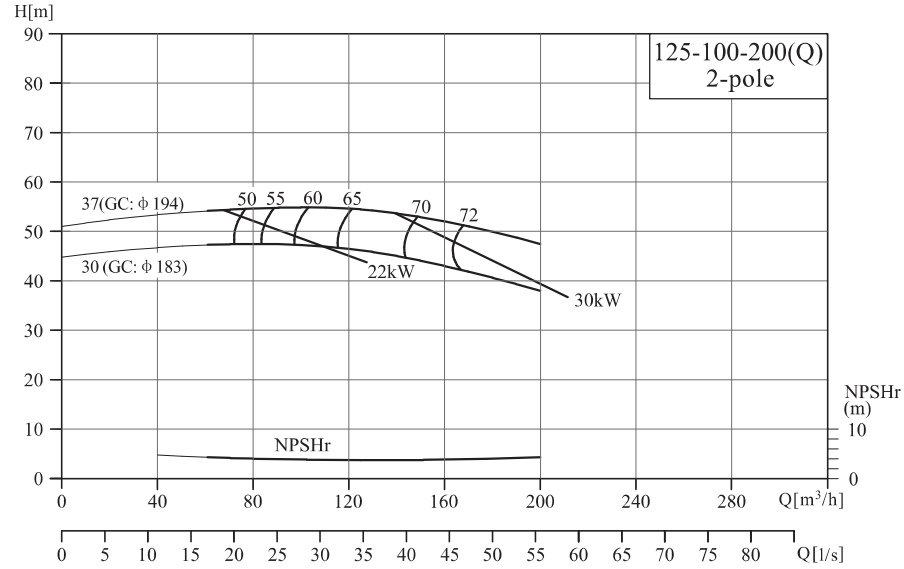

Performance curve

NIS125-100-250G/125-100-315G

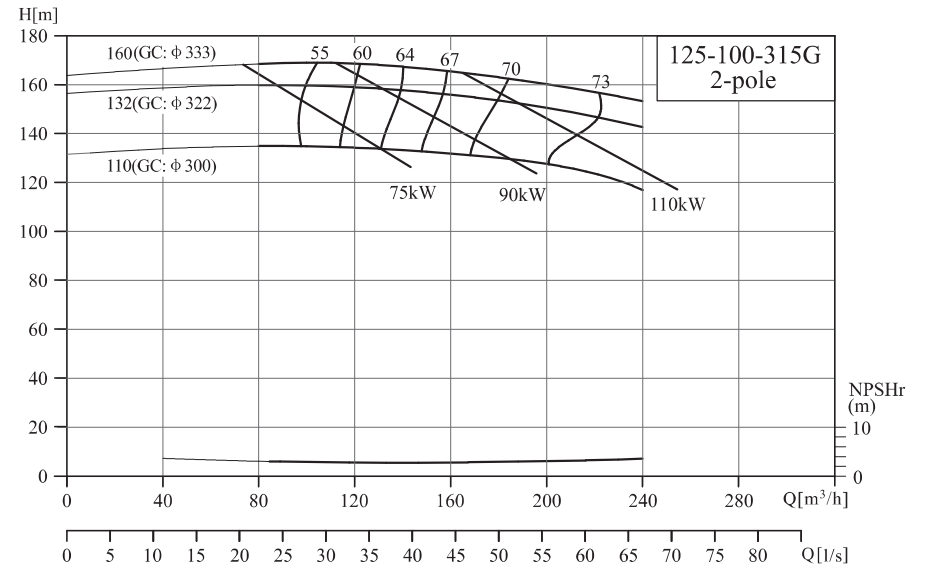
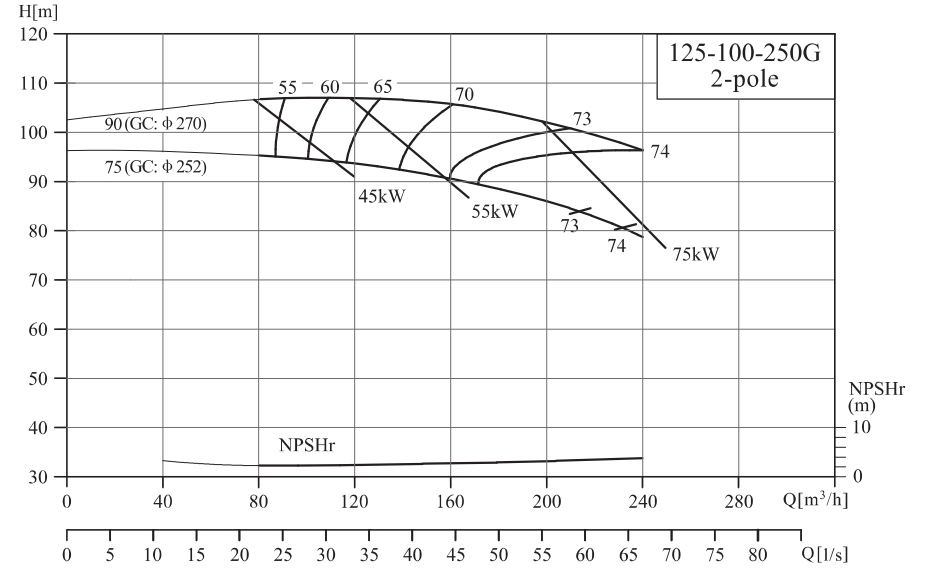

Performance curve

NIS100-65-200G/100-65-250G

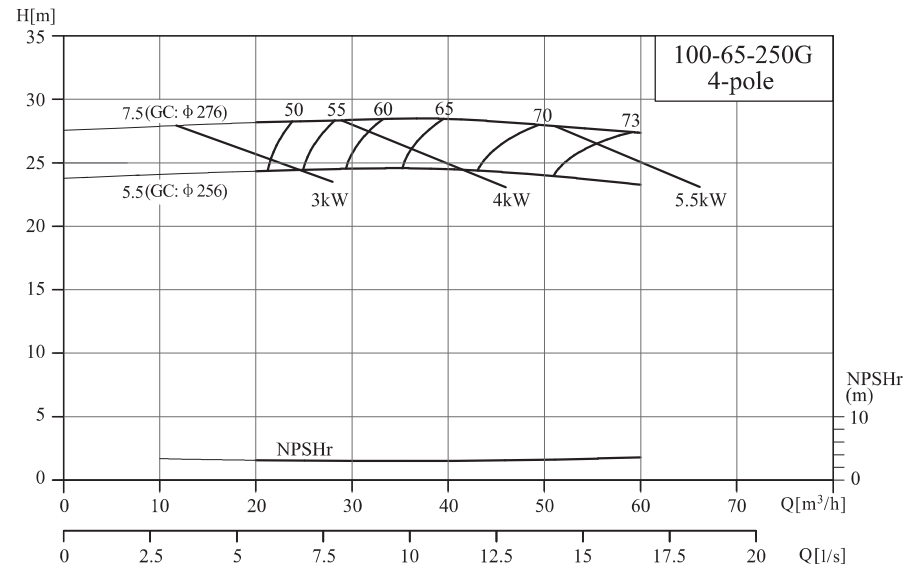
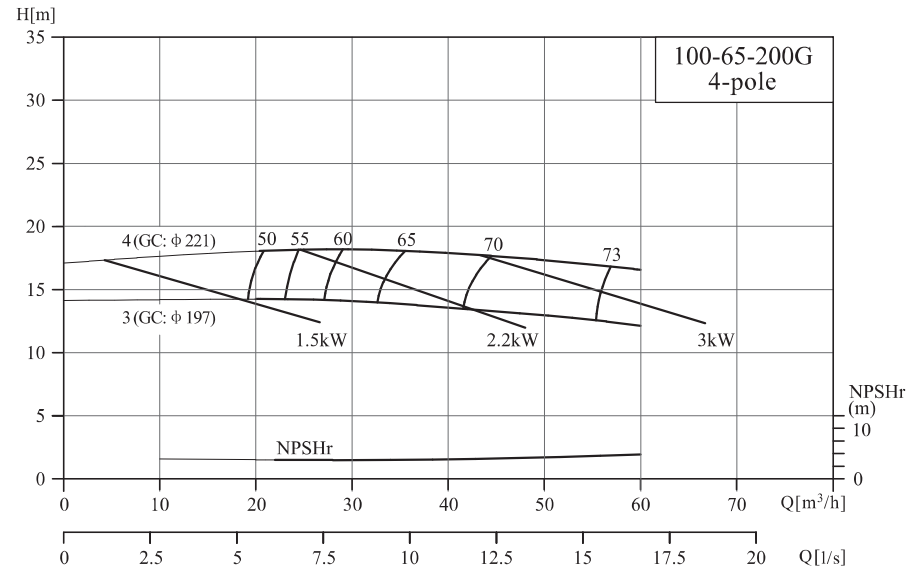

Performance curve

NIS100-65-315G/100-80-160G

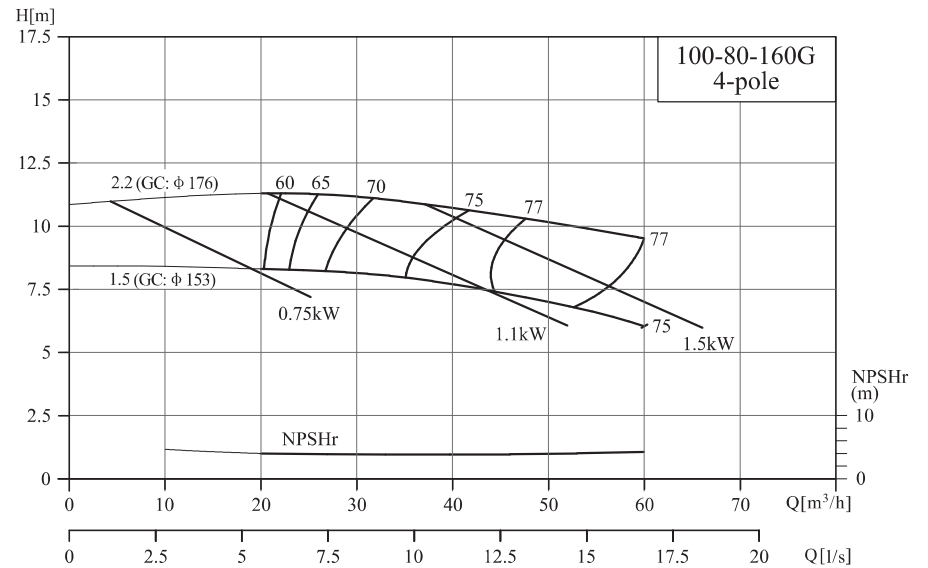
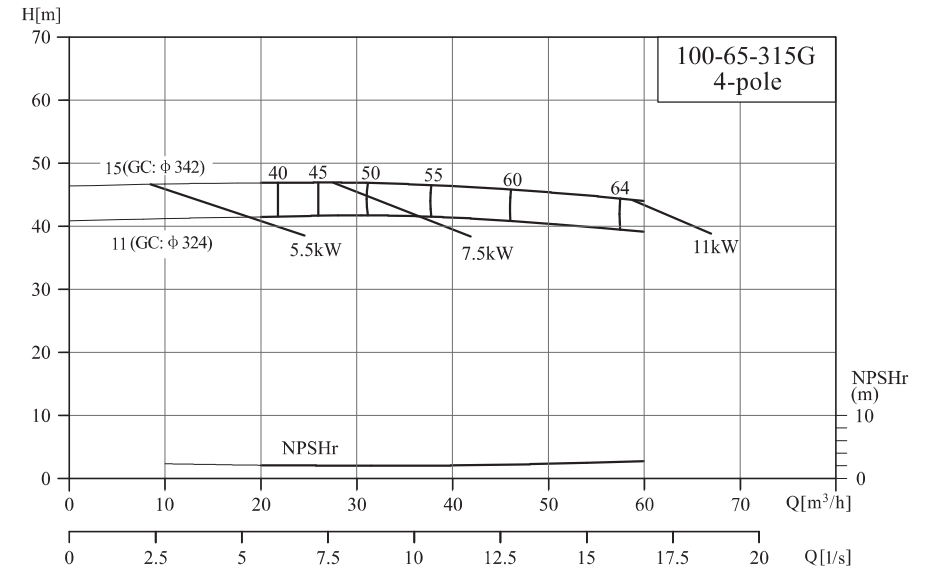

Performance curve

NIS125-100-200G/125-100-250G

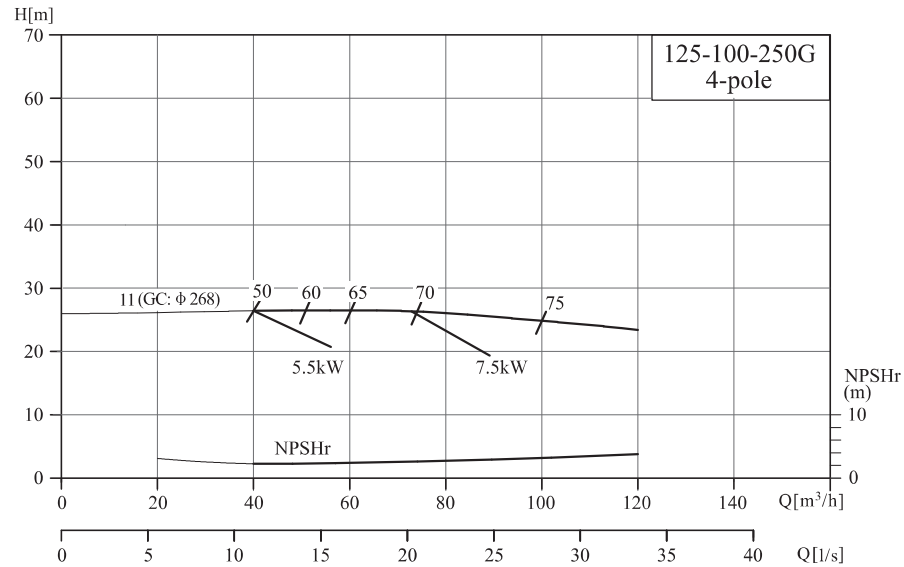
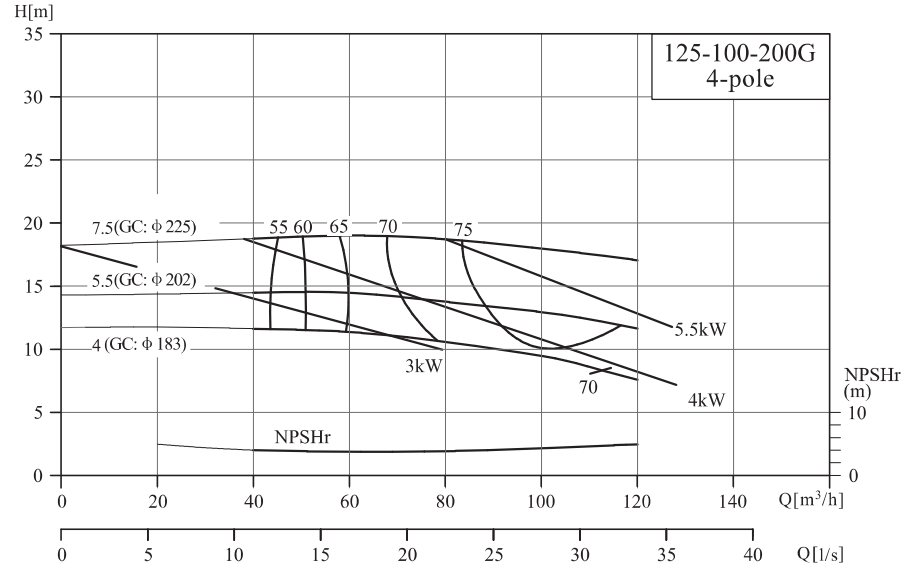

Performance curve

NIS125-100-315G/125-100-400G

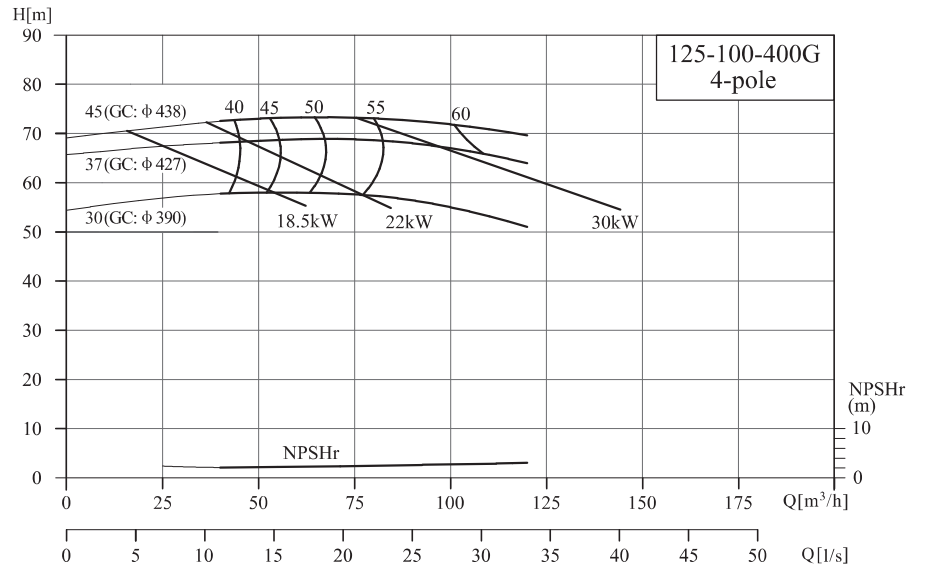
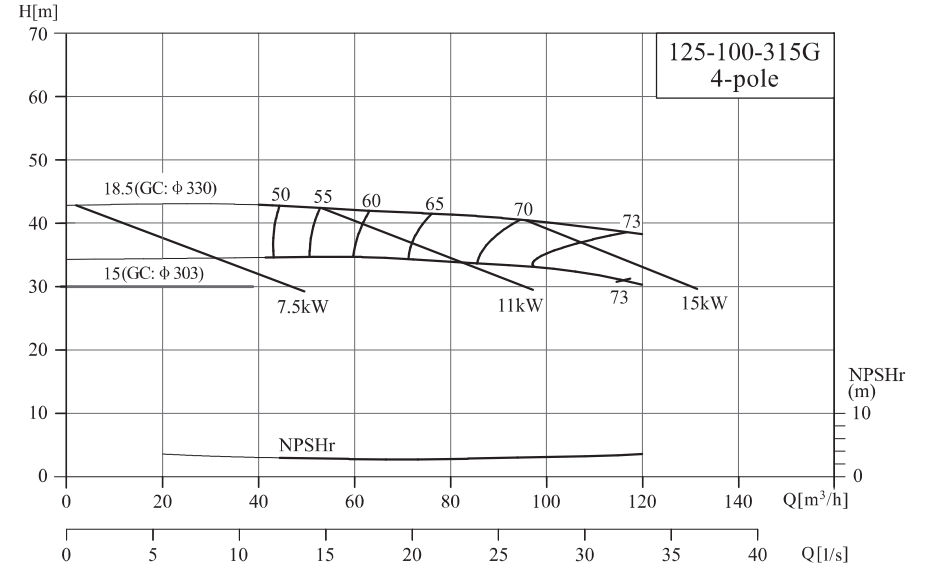

Performance curve

NIS150-125-200(Q)/150-125-200G

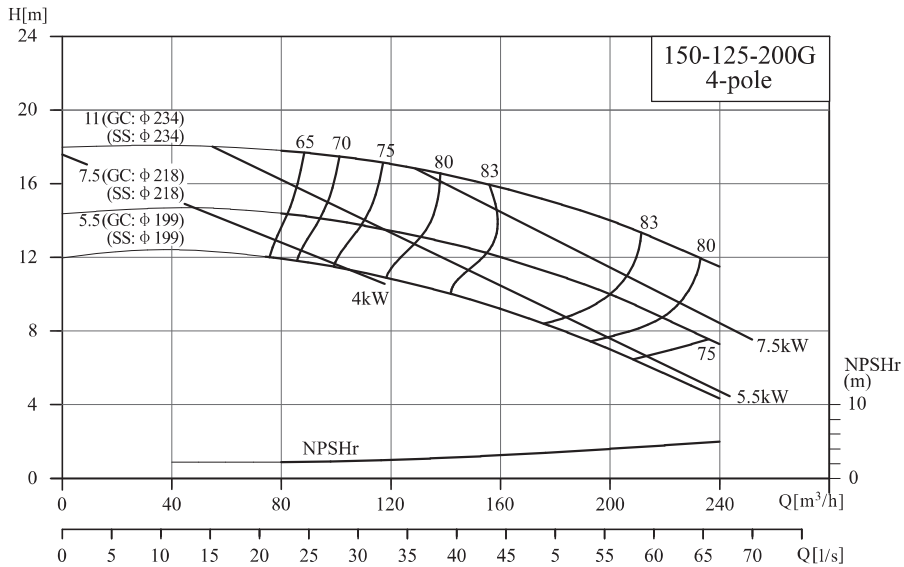
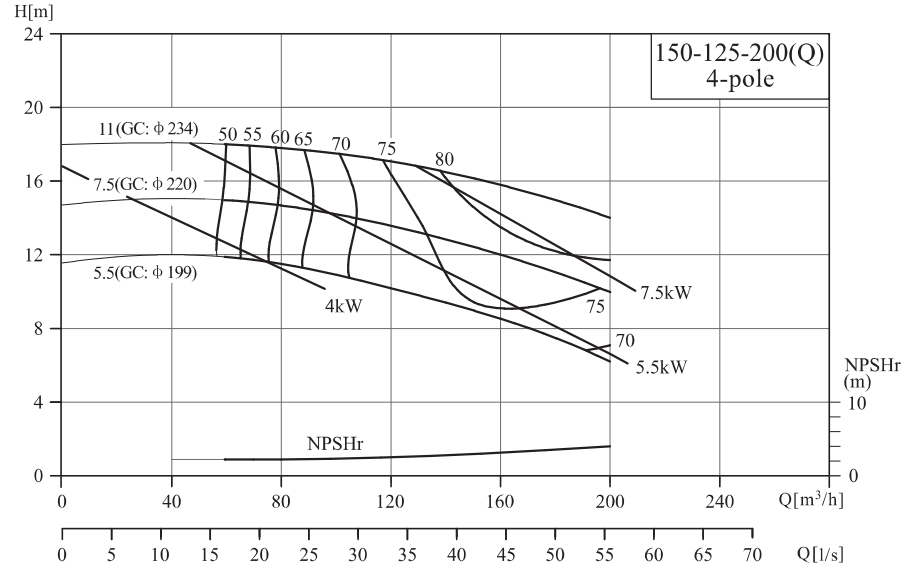

Performance curve

NIS150-125-250G/150-125-315(Q)

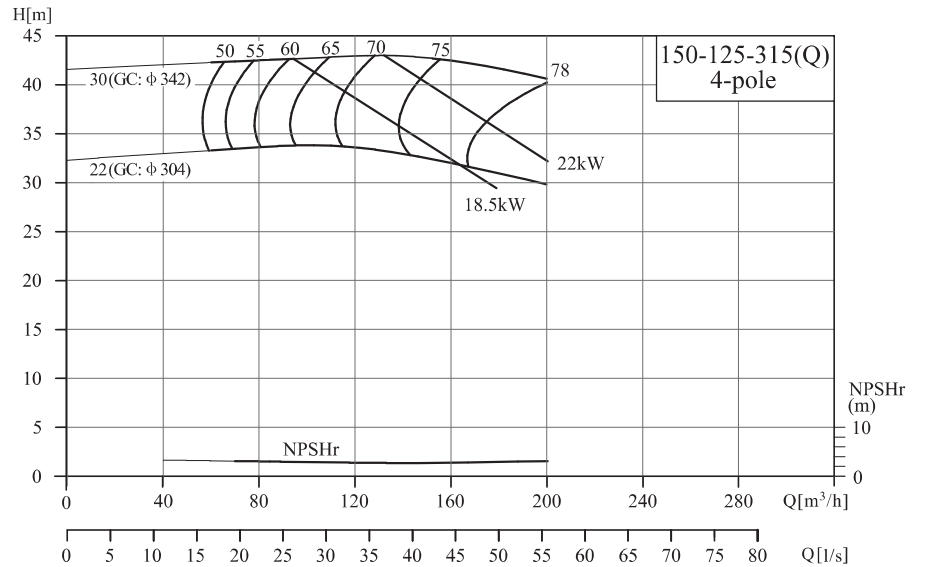
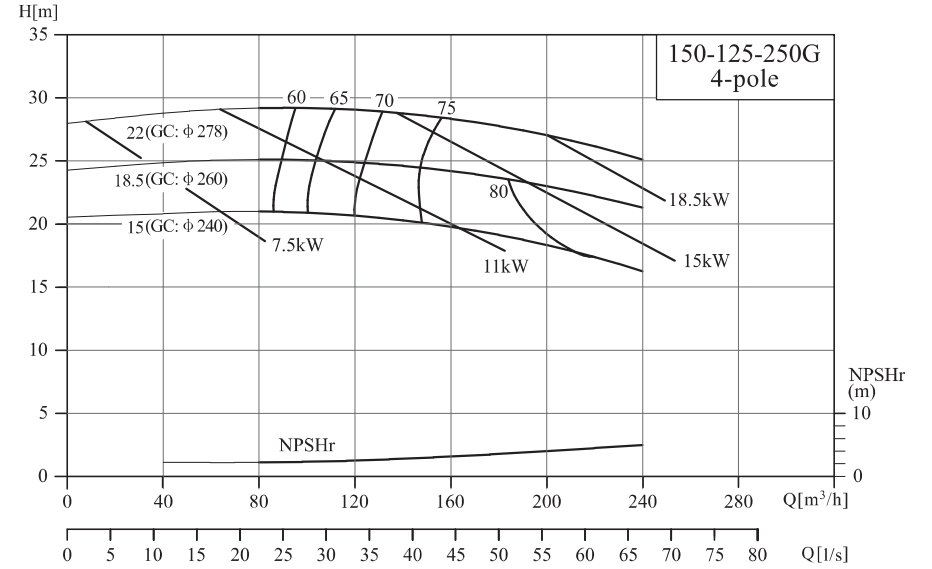

Performance curve

NIS150-125-315G/150-125-400(Q)

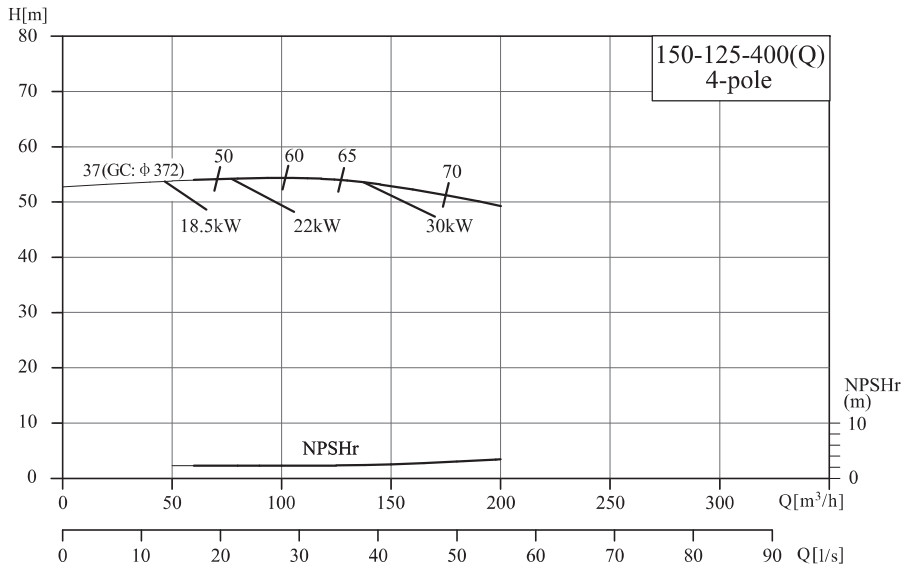
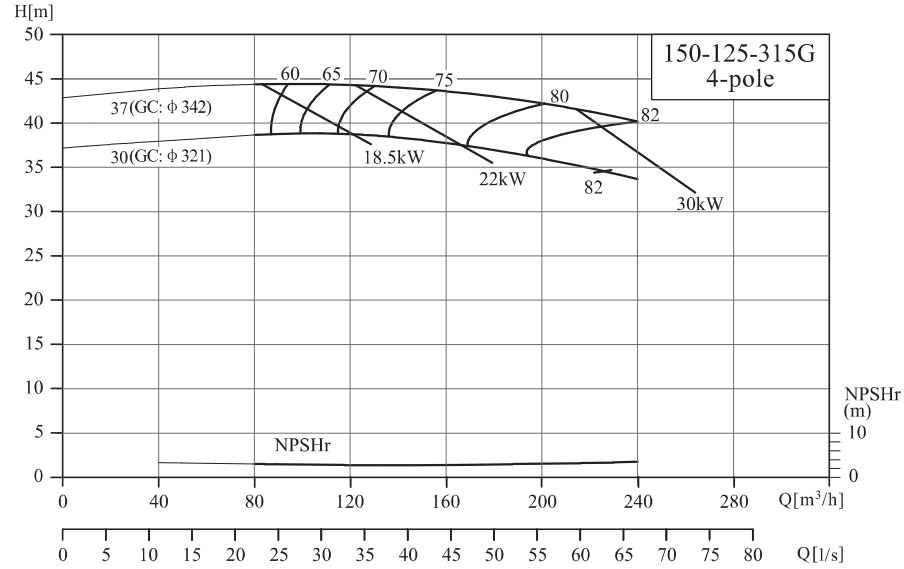

Performance curve

NIS150-125-400G/200-150-250(Q)

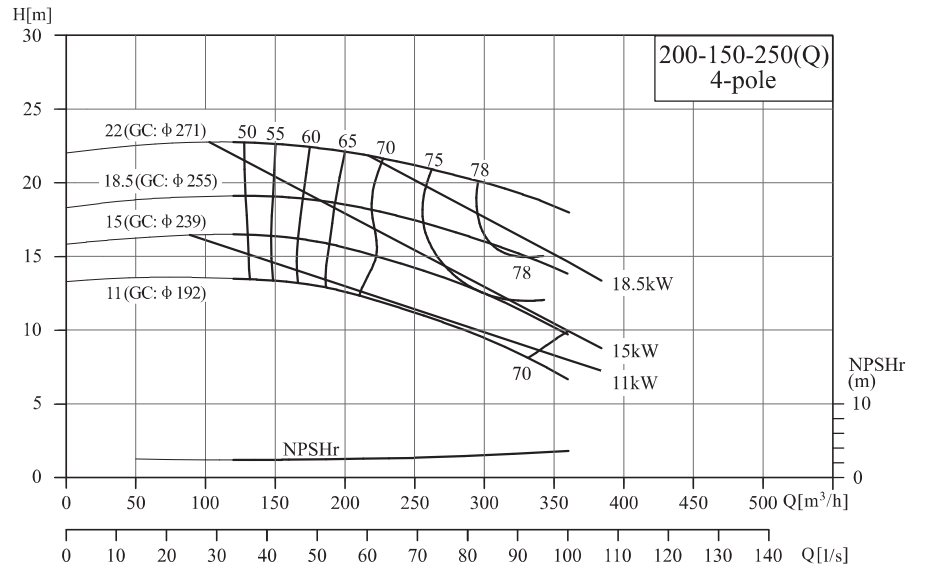
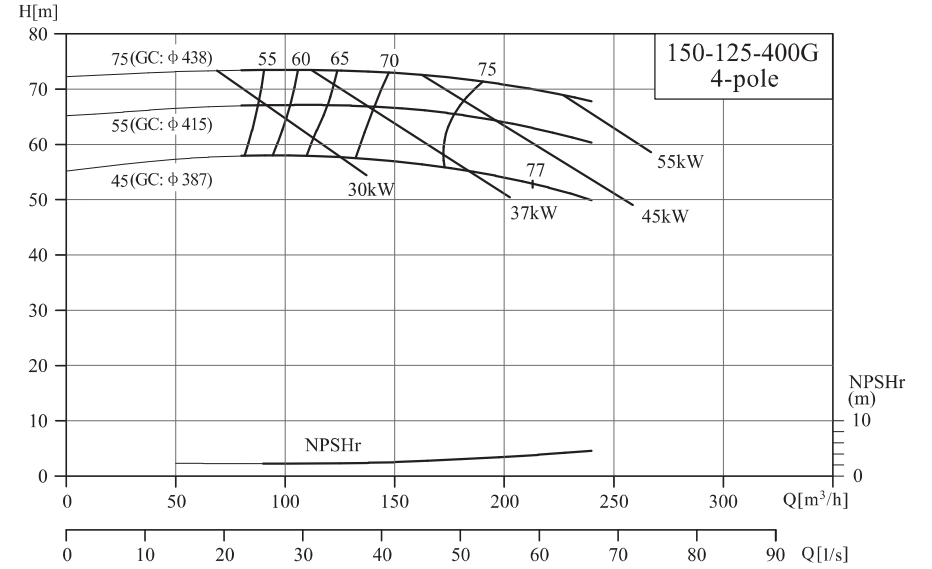

Performance curve

NIS200-150-250G/200-150-315G

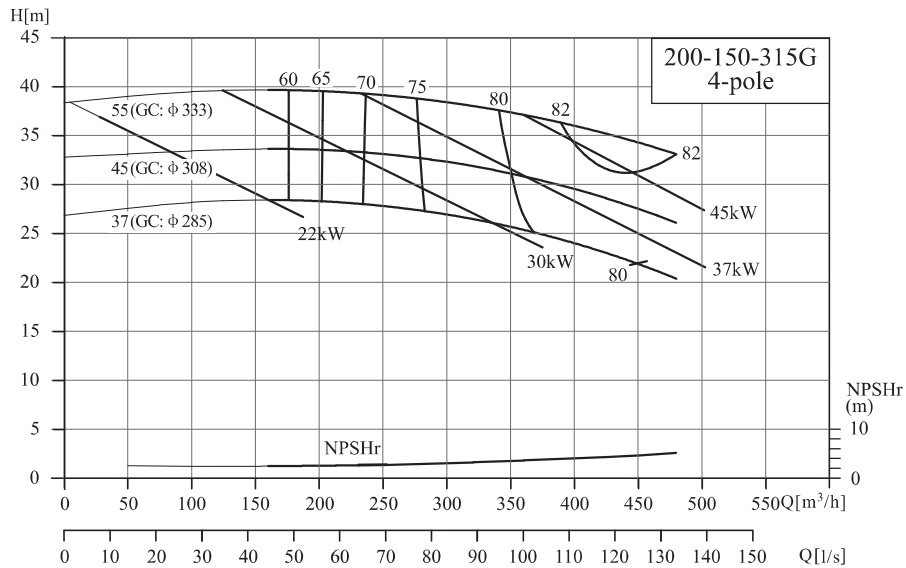
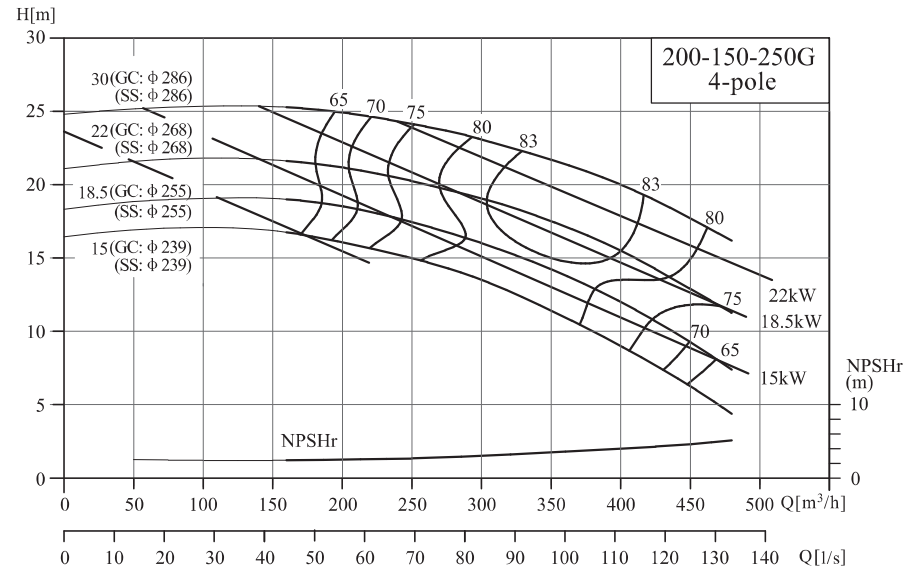

Performance curve

NIS200-150-400G

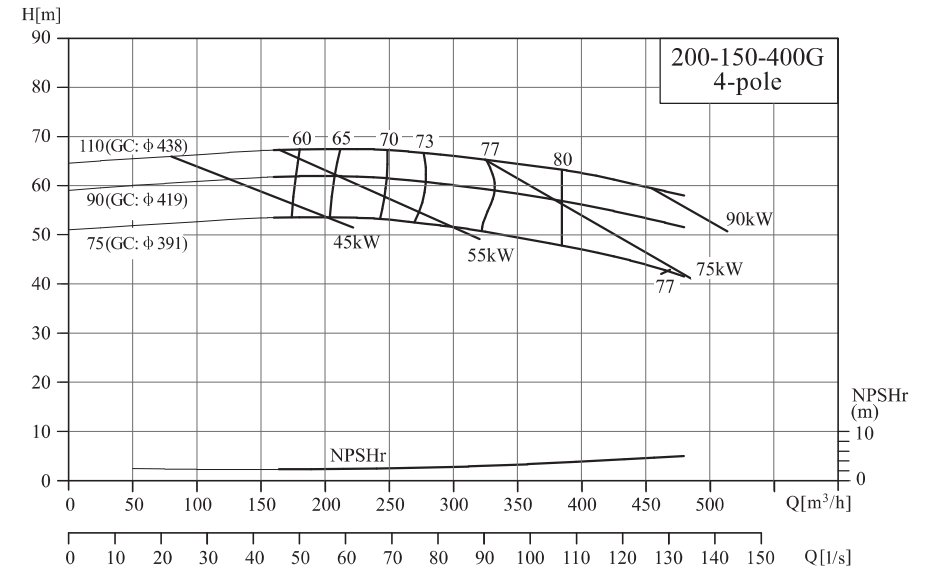

NIS*G,NIS*(Q) Dimension drawing

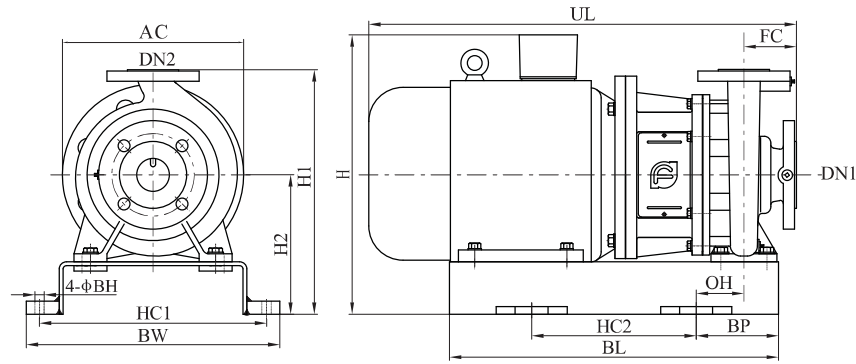

NIS*G,NIS*(Q) Dimension table

																2-pole
Model	Power (kW)	H	H1	H2	HC1	HC2	BW	BL	BP	BH	OH	UL	FC	DN1	DN2	Total weight (kg)
100-65-200G	18.5	520	485	260	390	400	420	660	130	18	63.5	865	100	100	65	222
	22	535	485	260	430	400	460	700	150	18	81.5	895	100	100	65	257
	30	585	505	280	470	450	500	750	150	18	81.5	967	100	100	65	318
	37	585	505	280	470	450	500	750	150	18	81.5	967	100	100	65	337
100-65-250G	45	640	555	305	520	500	560	820	160	22	76.5	1042	125	100	65	426
	55	715	600	350	585	550	625	950	200	22	116.5	1156	125	100	65	529
100-65-315G	75	780	660	380	630	600	670	1000	200	22	114	1245	125	100	65	693
	90	780	660	380	630	600	670	1100	250	22	164	1295	125	100	65	730
100-80-160G	11	515	440	240	390	400	420	660	130	18	61.5	810	100	100	80	177
	15	515	440	240	390	400	420	660	130	18	61.5	810	100	100	80	187
	18.5	515	440	240	390	400	420	660	130	18	61.5	865	100	100	80	207
	30	585	560	280	465	500	495	800	150	18	69	992	125	125	100	349
125-100-200(Q)	37	585	560	280	465	500	495	800	150	18	69	992	125	125	100	368
	30	585	560	280	465	500	495	800	150	18	69	992	125	125	100	349
125-100-200G	37	585	560	280	465	500	495	800	150	18	69	992	125	125	100	368
	45	640	585	305	520	500	560	820	160	22	76.5	1042	125	125	100	431
	55	715	630	350	585	550	625	950	200	22	116.5	1156	125	125	100	534
	75	780	660	380	630	600	670	1000	200	22	114	1231	125	125	100	678

NIS*G,NIS*(Q) Dimension table

																	2-pole
Model	Power (kW)	H	H1	H2	HC1	HC2	BW	BL	BP	BH	OH	UL	FC	DN1	DN2	Total weight (kg)	
125-100-250G	75	780	660	380	630	600	670	1000	200	22	114	1265	140	125	100	701	
	90	780	660	380	630	600	670	1100	250	22	164	1315	140	125	100	738	
125-100-315G	110	945	730	415	720	600	760	1100	250	22	164	1545	140	125	100	1170	
	132	945	730	415	720	700	760	1220	260	22	174	1655	140	125	100	1230	
	160	945	730	415	720	700	760	1220	260	22	174	1655	140	125	100	1350	

																	4-pole
Model	Power (kW)	H	H1	H2	HC1	HC2	BW	BL	BP	BH	OH	UL	FC	DN1	DN2	Total weight (kg)	
100-65-200G	3	430	485	260	386	300	416	500	100	14	35	591	100	100	65	109	
	4	448	485	260	386	300	416	500	100	14	35	606	100	100	65	114	
100-65-250G	5.5	493	530	280	430	350	460	550	100	14	20	687	125	100	65	147	
	7.5	493	530	280	430	350	460	550	100	18	20	727	125	100	65	166	
100-65-315G	11	565	585	305	470	400	500	700	150	18	70	854	125	100	65	249	
	15	565	585	305	470	400	500	700	150	18	70	909	125	100	65	270	
100-80-160G	1.5	400	440	240	350	250	380	410	105	14	40	536	100	100	80	76	
	2.2	410	440	240	350	300	380	500	100	14	35	591	100	100	80	87	
125-100-200G	4	468	560	280	430	300	460	500	100	14	20	631	125	125	100	136	
	5.5	493	560	280	430	350	460	550	100	18	20	687	125	125	100	152	
125-100-250G	7.5	493	560	280	430	350	460	550	100	18	20	727	125	125	100	171	
	11	565	585	305	470	400	500	700	150	18	70	924	140	125	100	258	
125-100-315G	15	590	645	330	470	400	500	700	150	18	69	869	140	125	100	281	
	18.5	605	645	330	470	450	500	750	150	18	69	954	140	125	100	317	
125-100-400G	30	665	715	360	580	500	620	800	150	22	50	1028	140	125	100	444	
	37	715	735	380	585	550	625	950	200	22	100	1071	140	125	100	523	
	45	715	735	380	585	550	625	950	200	22	100	1101	140	125	100	552	
150-125-200(Q)	5.5	543	630	330	470	350	500	570	100	18	20	721	140	150	125	168	
	7.5	543	630	330	470	350	500	570	100	18	20	761	140	150	125	180	
150-125-200G	11	590	630	330	470	400	500	700	150	18	69	869	140	150	125	235	
	5.5	543	630	330	470	350	500	570	100	18	20	721	140	150	125	168	
150-125-250G	7.5	543	630	330	470	350	500	570	100	18	20	761	140	150	125	180	
	11	590	630	330	470	400	500	700	150	18	69	869	140	150	125	235	
	15	590	685	330	470	400	500	700	150	18	69	924	140	150	125	284	
150-125-250G	18.5	605	685	330	470	450	500	750	150	18	69	954	140	150	125	315	
	22	605	685	330	470	450	500	750	150	18	69	994	140	150	125	333	

NIS*G,NIS*(Q) Dimension table

4-pole

Model	Power (kW)	H	H1	H2	HC1	HC2	BW	BL	BP	BH	OH	UL	FC	DN1	DN2	Total weight (kg)
150-125-315(Q)	22	635	715	360	580	500	620	800	150	22	50	994	140	150	125	400
	30	665	715	360	580	500	620	800	150	22	50	1028	140	150	125	430
150-125-315G	30	665	715	360	580	500	620	800	150	22	50	1028	140	150	125	430
	37	715	735	380	585	550	625	950	200	22	100	1071	140	150	125	507
150-125-400(Q)	37	750	815	415	585	550	625	950	200	22	100	1071	140	150	125	521
	45	750	815	415	585	550	625	950	200	22	100	1103	140	150	125	561
150-125-400G	55	780	815	415	585	550	625	950	200	22	100	1187	140	150	125	620
	75	815	815	415	630	600	670	1000	200	22	100	1262	140	150	125	776
200-150-250(Q)	11	620	735	360	580	500	620	800	150	22	50	901	160	200	150	273
	15	620	735	360	580	500	620	800	150	22	50	956	160	200	150	299
	18.5	635	735	360	580	500	620	800	150	22	50	988	160	200	150	337
	22	635	735	360	580	500	620	800	150	22	50	1026	160	200	150	360
200-150-250G	15	620	735	360	580	500	620	800	150	22	50	956	160	200	150	299
	18.5	635	735	360	580	500	620	800	150	22	50	988	160	200	150	337
	22	635	735	360	580	500	620	800	150	22	50	1026	160	200	150	360
	30	665	735	360	580	500	620	800	150	22	50	1048	160	200	150	426
200-150-315G	37	750	815	415	605	500	670	900	200	22	100	1116	160	200	150	541
	45	750	815	415	605	500	645	900	200	22	100	1146	160	200	150	579
	55	780	815	415	605	600	645	1000	200	22	100	1254	160	200	150	650
200-150-400G	75	815	865	415	630	600	675	1100	250	22	150	1329	160	200	150	859
	90	815	865	415	630	600	675	1100	250	22	150	1379	160	200	150	956
	110	945	865	415	720	700	760	1220	260	22	160	1614	160	200	150	1325

NIS*G,NIS*(Q) Flange

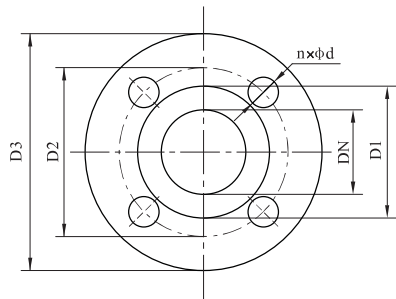

NIS*G,NIS*(Q) Flange dimension

DN	D1	D2	D3	n	d
65	122	145	185	4	18
80	133	160	200	8	18
100	158	180	220	8	18
125	184	210	250	8	18
150	212	240	285	8	22
200	268	295	340	12	22

NISO, NIS, NISF Product range

2-pole

No.	Model	Q [m³/h]	H [m]	Motor [kW]	n [r/min]
1	50-32-160/3	12.5	28	3	2900
2	50-32-160/4		36	4	
3	50-32-160/5.5		44	5.5	
4	50-32-200/7.5		55	7.5	
5	50-32-200/11		74	11	
6	65-40-200/7.5	25	48	7.5	2900
7	65-40-200/11		62	11	
8	65-40-200/15		72	15	
9	65-40-250/18.5		84	18.5	
10	65-40-250/22		95	22	
11	65-40-250/30		105	30	2950
12	65-40-315/22		105	22	
13	65-40-315/30		120	30	
14	65-40-315/37		145	37	
15	65-40-315/45		165	45	
16	65-50-160/4	50	28	4	2900
17	65-50-160/5.5		36	5.5	
18	65-50-160/7.5		42	7.5	
19	80-50-200/11		44	11	
20	80-50-200/15		57	15	
21	80-50-200/18.5		64	18.5	
22	80-50-200/22		71	22	
23	80-50-250/30		84	30	2950
24	80-50-250/37		100	37	
25	80-50-315/37		105	37	
26	80-50-315/45	125	45		
27	80-50-315/55	140	55		
28	80-50-315/75	152	75		

NISO, NIS, NISF Product range

2-pole

No.	Model	Q [m³/h]	H [m]	Motor [kW]	n [r/min]
29	80-65-160/5.5	50	22	5.5	2900
30	80-65-160/7.5		29	7.5	
31	80-65-160/11		38	11	
32	80-65-160/15		44	15	
33	100-65-200/18.5	100	36	18.5	2950
34	100-65-200/22		43	22	
35	100-65-200/30		56	30	
36	100-65-200/37		67	37	
37	100-65-250/45		80	45	
38	100-65-250/55		88	55	
39	100-65-250/75		108	75	
40	100-65-315/90		128	90	
41	100-65-315/110		148	110	
42	100-80-160/11		23	11	
43	100-80-160/15	30	15		
44	100-80-160/18.5	35	18.5		
45	100-80-160/22	40	22		
46	125-100-200/30	200	34	30	2950
47	125-100-200/37		41	37	
48	125-100-200/45		48	45	
49	125-100-200/55		55	55	
50	125-100-200/75		66	75	
51	125-100-250/75		75	75	
52	125-100-250/90		86	90	
53	125-100-250/110		100	110	
54	125-100-315/90		93	90	
55	125-100-315/110		108	110	
56	125-100-315/132		124	132	
57	125-100-315/160	144	160		

NISO, NIS, NISF Product range

4-pole

No.	Model	Q [m³/h]	H [m]	Motor [kW]	n [r/min]
1	50-32-160/0.55	6.3	8.5	0.55	1450
2	50-32-160/0.75		11	0.75	
3	50-32-200/1.1		14	1.1	
4	50-32-200/1.5		18	1.5	
5	65-40-200/1.1	12.5	12	1.1	1450
6	65-40-200/1.5		15	1.5	
7	65-40-200/2.2		17.5	2.2	
8	65-40-250/3		25	3	
9	65-40-315/4		34	4	
10	65-40-315/5.5		40	5.5	
11	65-50-160/0.55	25	7	0.55	1450
12	65-50-160/0.75		9	0.75	
13	65-50-160/1.1		10.5	1.1	
14	80-50-200/1.5		11	1.5	
15	80-50-200/2.2		15	2.2	
16	80-50-200/3		17.5	3	
17	80-50-250/4		21	4	
18	80-50-250/5.5		25	5.5	
19	80-50-315/5.5		30	5.5	
20	80-50-315/7.5		37	7.5	
21	80-65-160/0.75		6	0.75	
22	80-65-160/1.1	8	1.1		
23	80-65-160/1.5	10.5	1.5		
24	100-65-200/3	50	11.5	3	1480
25	100-65-200/4		14	4	
26	100-65-200/5.5		16	5.5	
27	100-65-250/5.5		20	5.5	
28	100-65-250/7.5		25	7.5	
29	100-65-315/11	32	11		

NISO, NIS, NISF Product range

4-pole

No.	Model	Q [m³/h]	H [m]	Motor [kW]	n [r/min]
30	100-65-315/15	50	40	15	1480
31	100-80-160/1.5		6.5	1.5	1450
32	100-80-160/2.2		9	2.2	
33	100-80-160/3		10.5	3	
34	125-80-400/15		39	15	1480
35	125-80-400/18.5		45	18.5	
36	125-80-400/22		50	22	
37	125-80-400/30		60	30	
38	125-80-400/37		67	37	1450
39	125-100-200/4		9	4	
40	125-100-200/5.5	11.5	5.5		
41	125-100-200/7.5	14	7.5		
42	125-100-200/11	16.5	11	1480	
43	125-100-250/15	25	15		
44	125-100-315/11	23	11		
45	125-100-315/18.5	32	18.5		
46	125-100-315/22	36	22	1480	
47	125-100-315/30	40	30		
48	125-100-400/30	50	30		
49	125-100-400/37	58	37		
50	125-100-400/45	65	45		
51	150-125-250/11	200	12.5		11
52	150-125-250/15		16		15
53	150-125-250/18.5		20		18.5
54	150-125-250/22		24		22
55	150-125-315/30		32		30
56	150-125-315/37		39	37	
57	150-125-400/45		50	45	
58	150-125-400/55		57	55	

NISO, NIS, NISF Product range

4-pole

No.	Model	Q [m³/h]	H [m]	Motor [kW]	n [r/min]	
59	150-125-400/75	200	68	75	1480	
60	200-150-315/37	400	23	37		
61	200-150-315/45		27	45		
62	200-150-315/55		32	55		
63	200-150-315/75		38	75		
64	200-150-400/75		43	75		
65	200-150-400/90		50	90		
66	200-150-400/110		62	110		
67	250-200-315/37		500	20		37
68	250-200-315/45			23		45
69	250-200-315/55		630	24	55	
70	250-200-315/75	32		75		
71	250-200-400/90	37		90		
72	250-200-400/110	44		110		
73	250-200-400/132	53		132		
74	250-200-400/160	60		160		
75	300-250-315(Q)/75	800	26	75		
76	300-250-315(Q)/90		32	90		
77	300-250-315(Q)/110		35	110		
78	300-250-400(Q)/110		38	110		
79	300-250-400(Q)/132		45	132		
80	300-250-400(Q)/160		53	160		
81	300-250-400(Q)/200	63	200			
82	300-250-315/75	1000	20	75		
83	300-250-315/90		25	90		
84	300-250-315/110		31	110		
85	300-250-400/132		37	132		
86	300-250-400/160		45	160		
87	300-250-400/200		50	200		

Performance curve

NISO, NIS, NISF 50-32-160/50-32-200

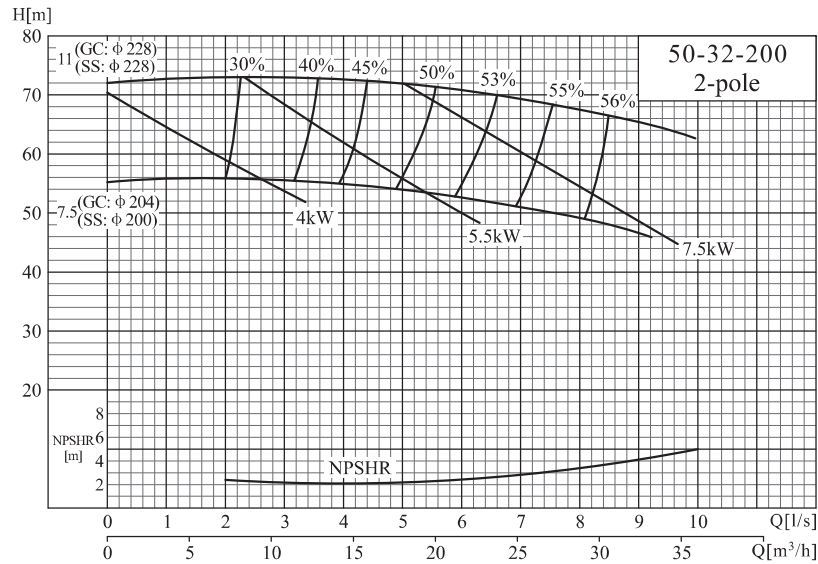
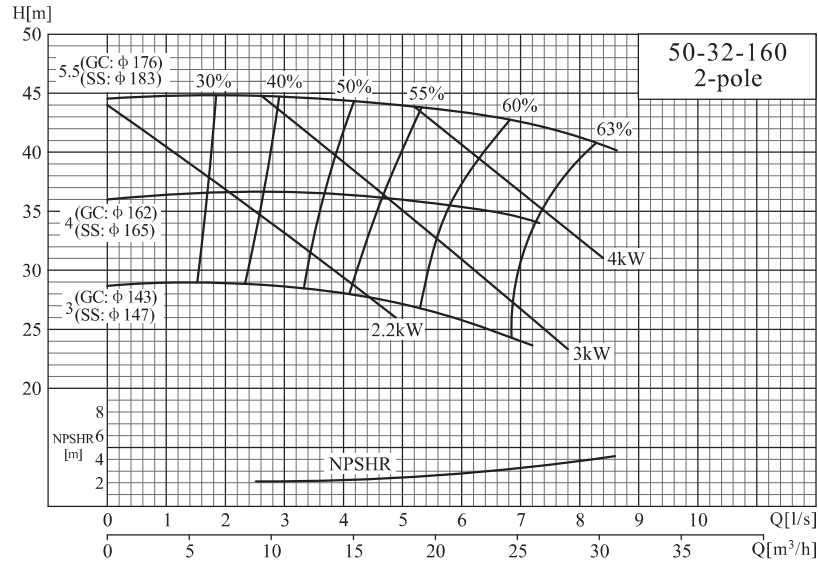

Performance curve

NISO, NIS, NISF 65-40-200/65-40-250

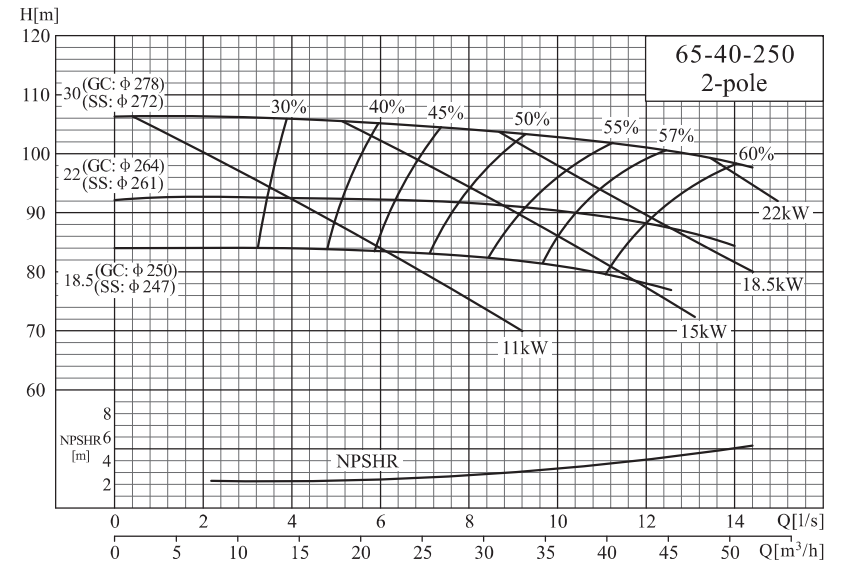
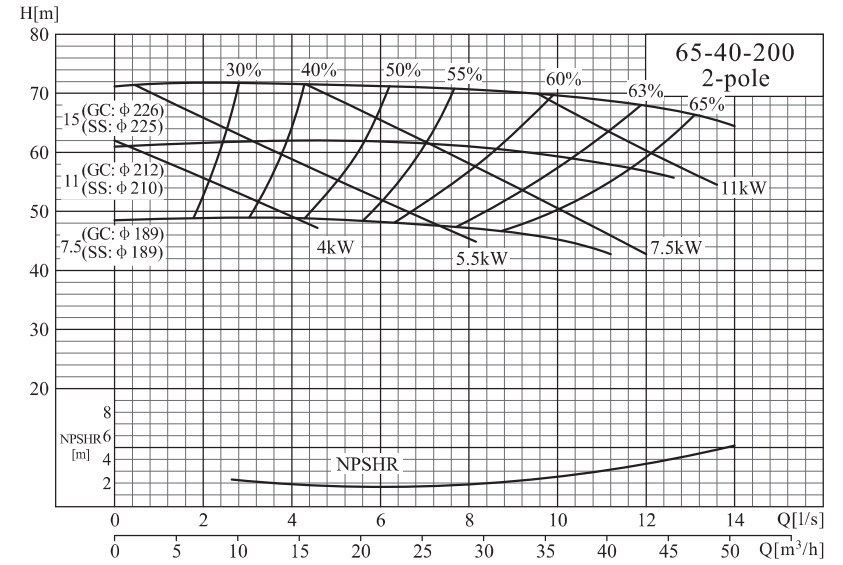

Performance curve

NISO, NIS, NISF 65-40-315/65-50-160

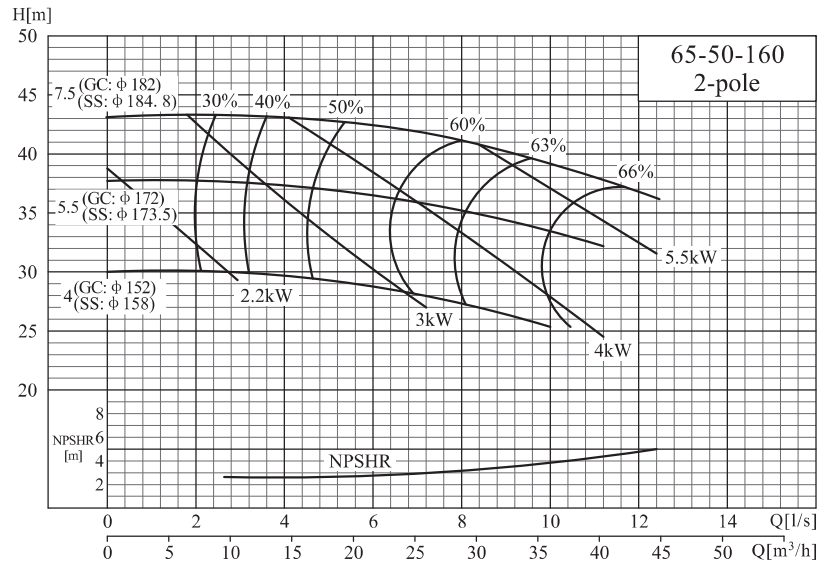
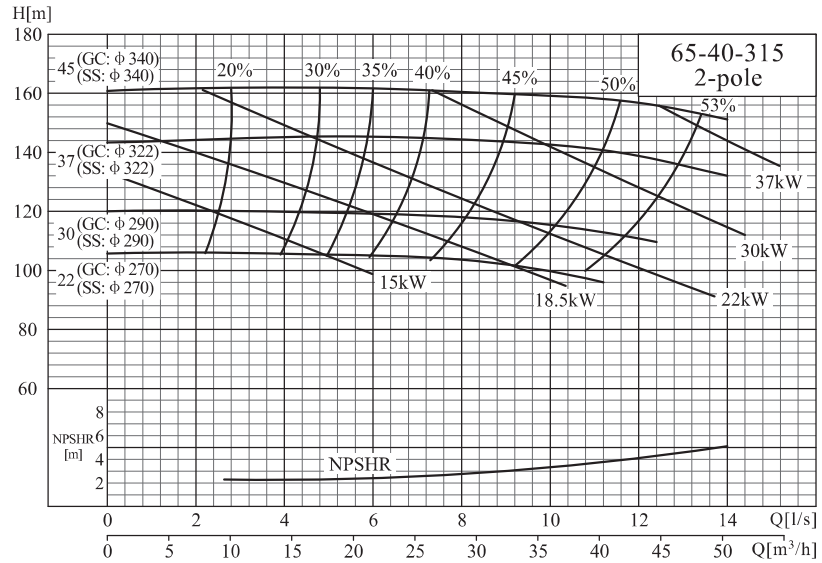

Performance curve

NISO, NIS, NISF 80-50-200/80-50-250

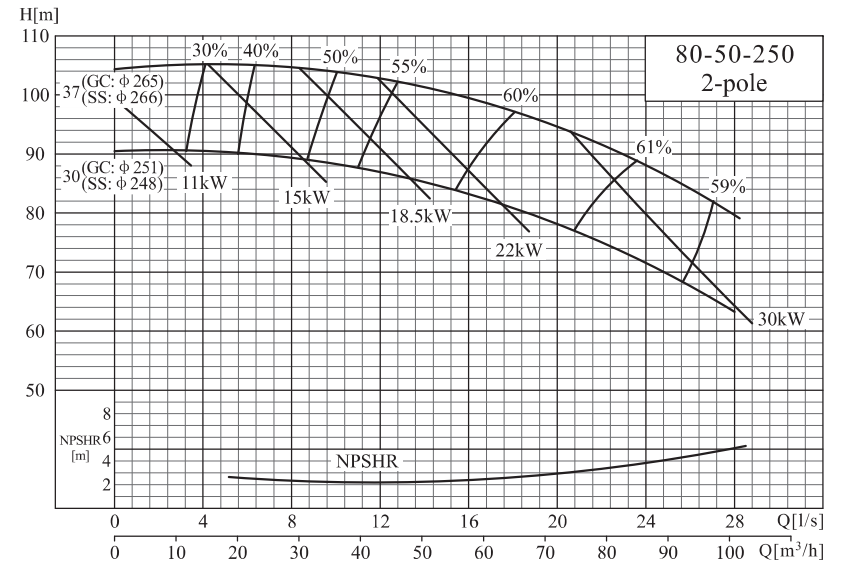
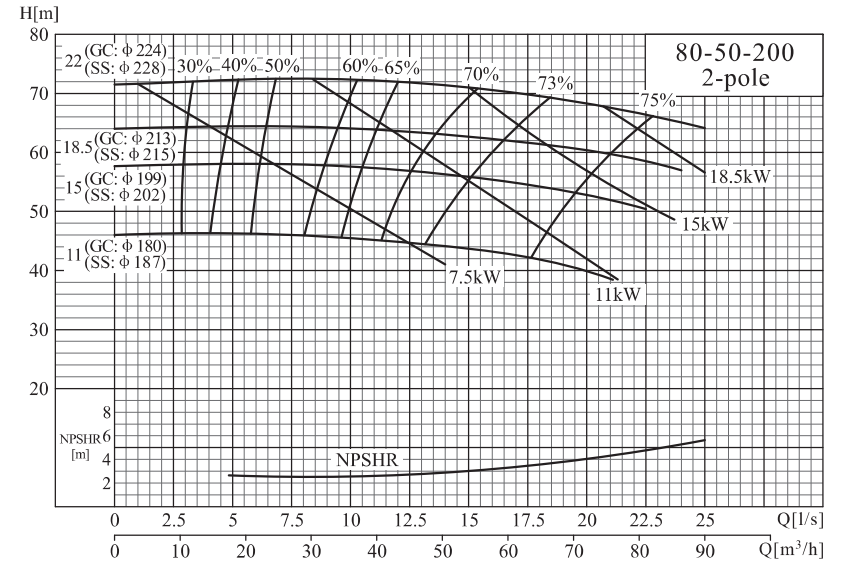

Performance curve

NISO, NIS, NISF 80-50-315/80-65-160

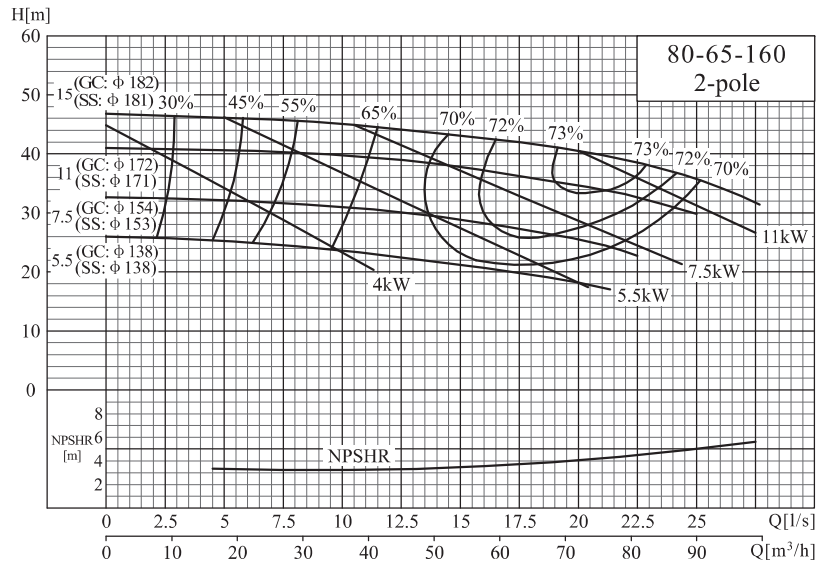
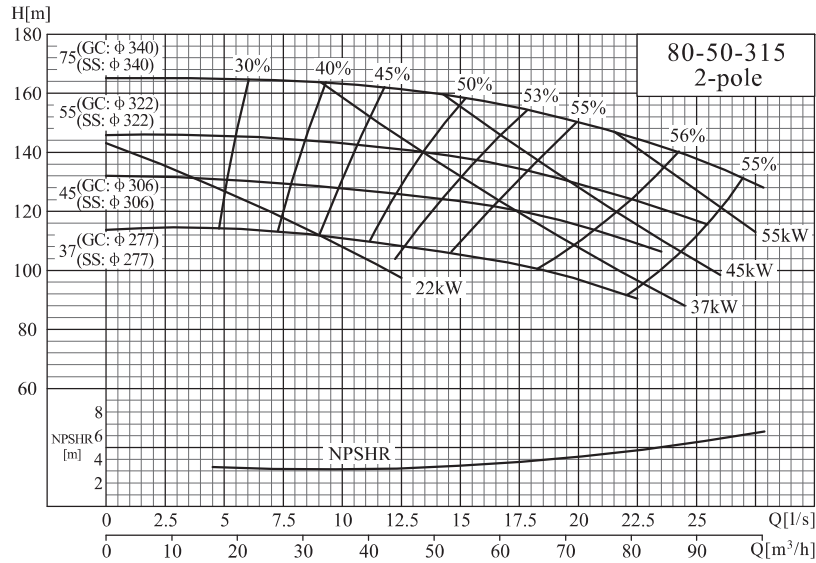

Performance curve

NISO, NIS, NISF 100-65-200/100-65-250

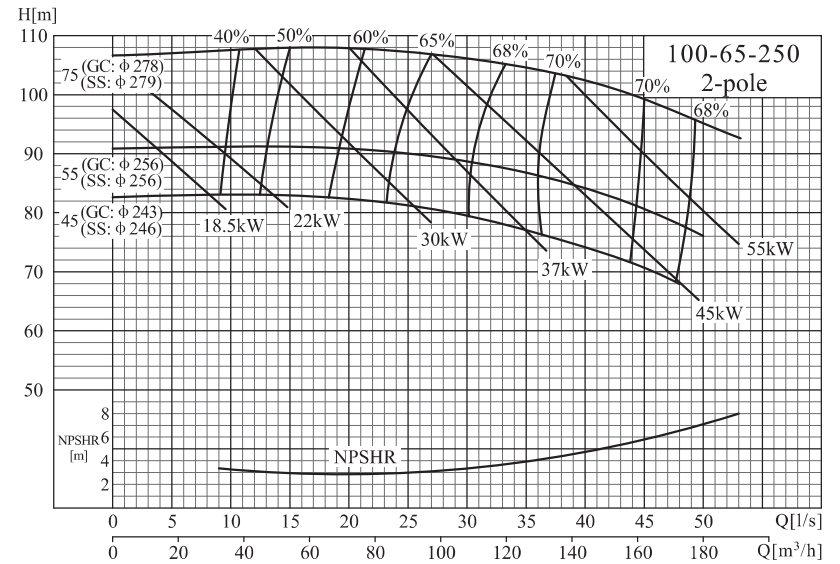
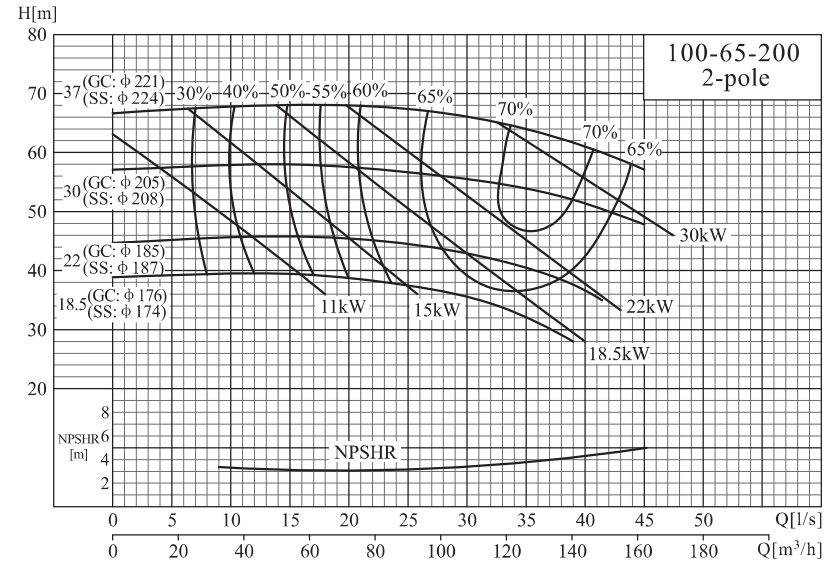

Performance curve

NISO, NIS, NISF 100-65-315/100-80-160

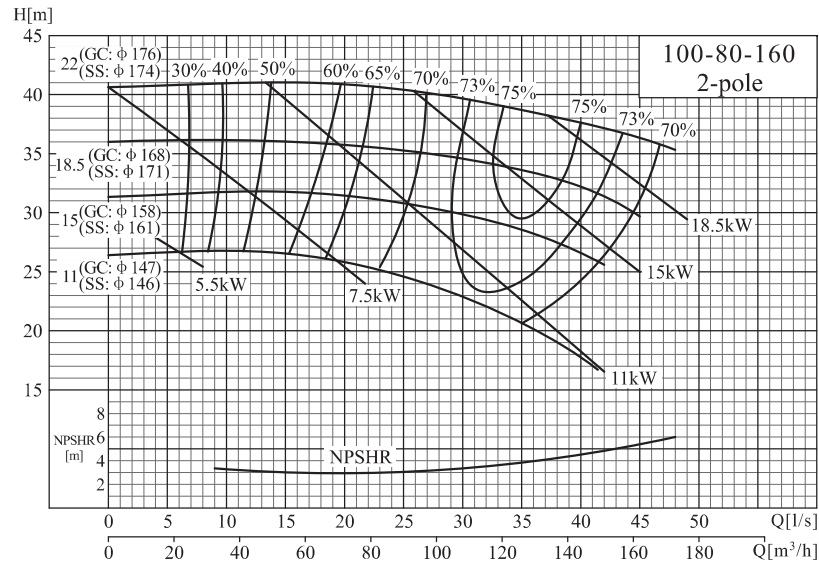
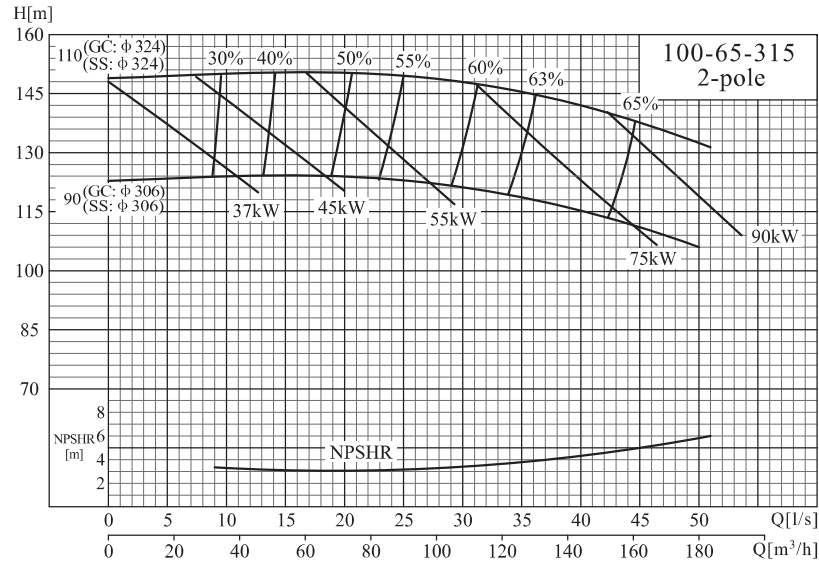

Performance curve

NISO, NIS, NISF 125-100-200/125-100-250

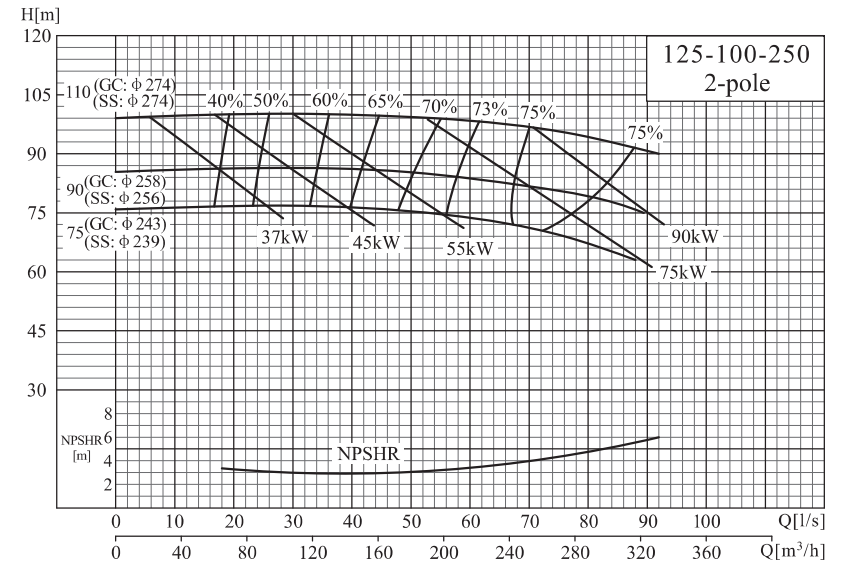
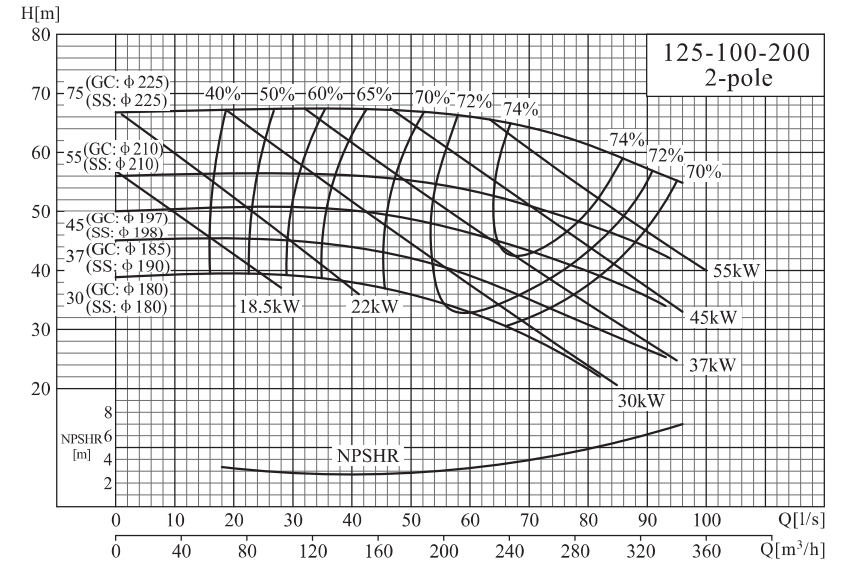

Performance curve

NISO, NIS, NISF 125-100-315/50-32-160

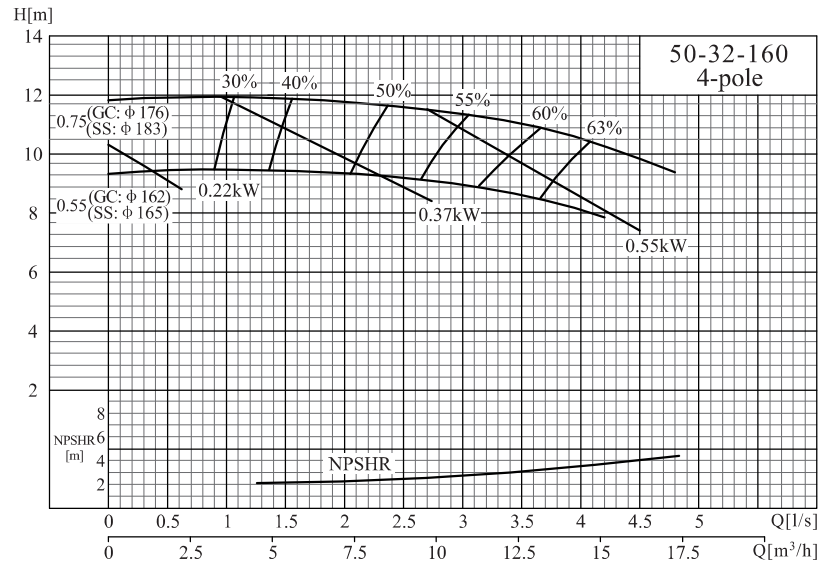
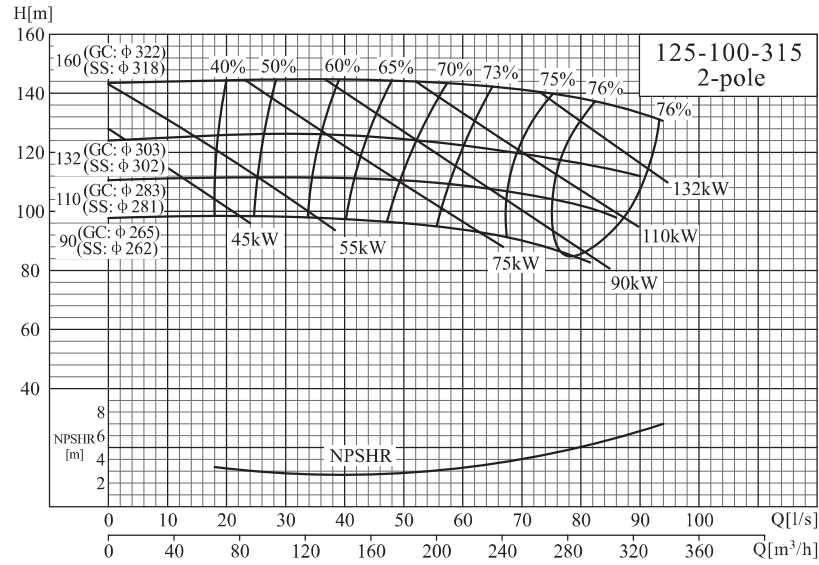

Performance curve

NISO, NIS, NISF 50-32-200/65-40-200

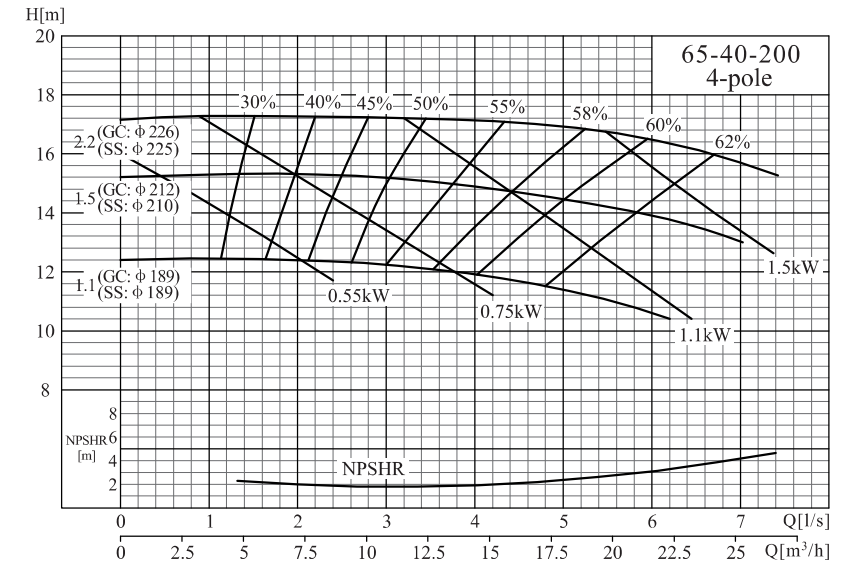
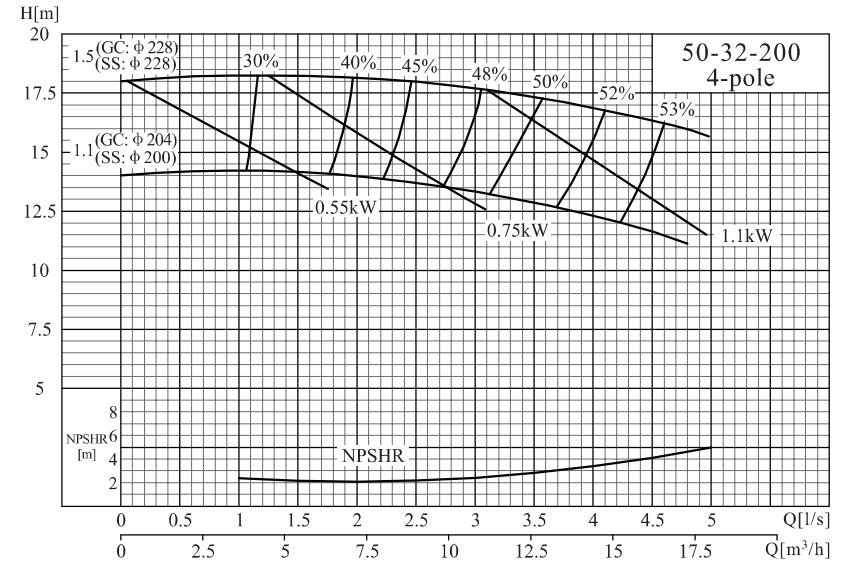

Performance curve

NISO, NIS, NISF 65-40-250/65-40-315

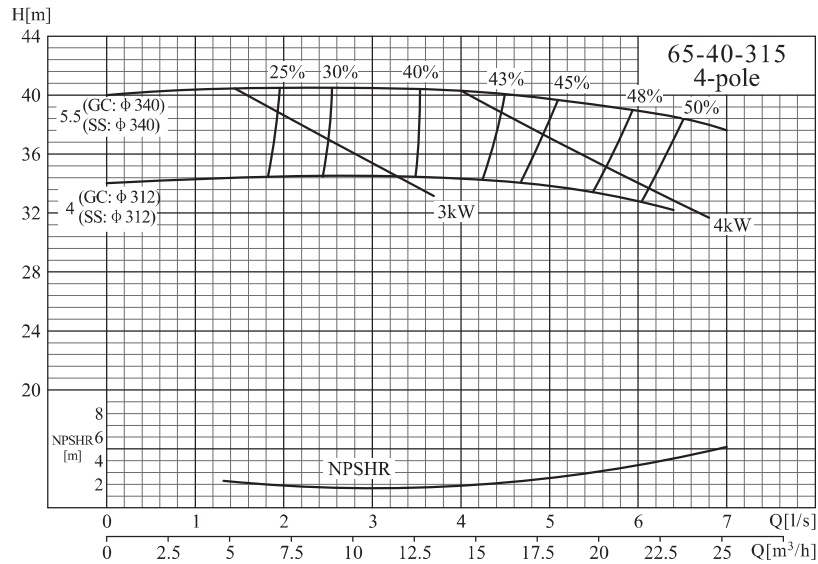
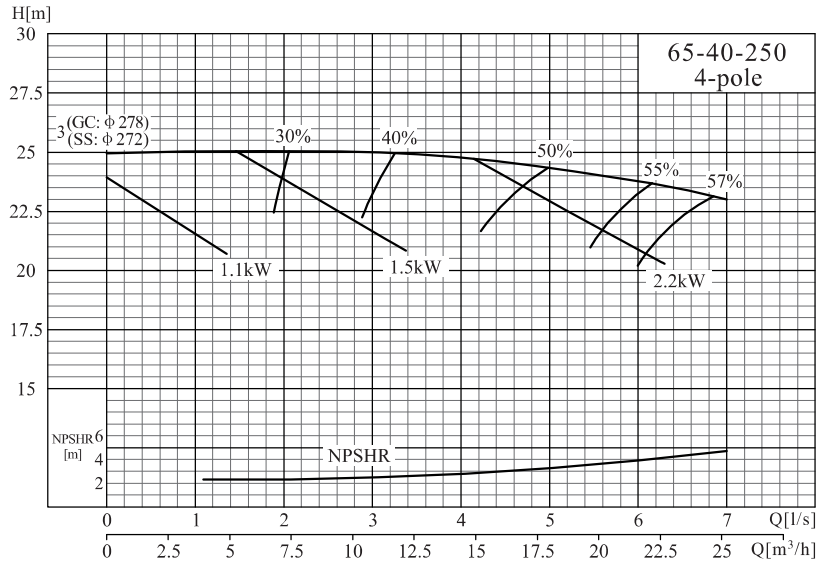

Performance curve

NISO, NIS, NISF 65-50-160/80-50-200

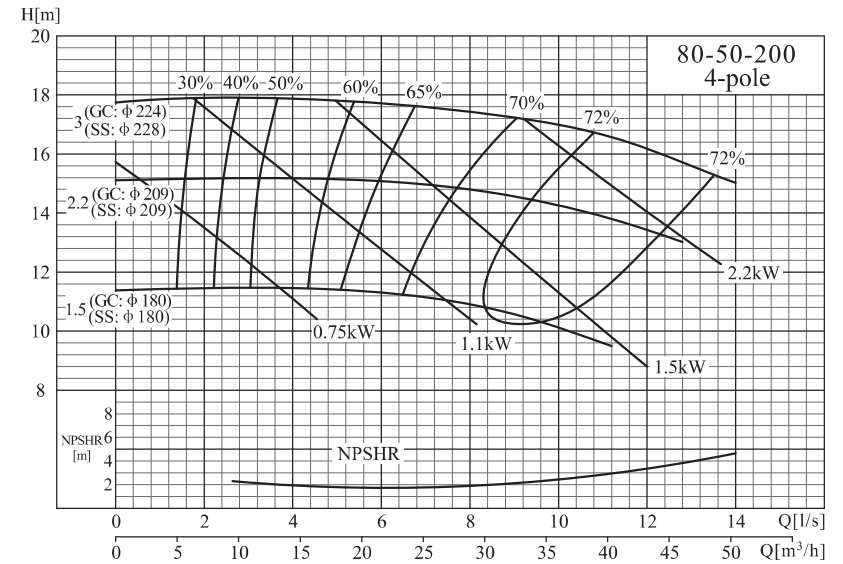
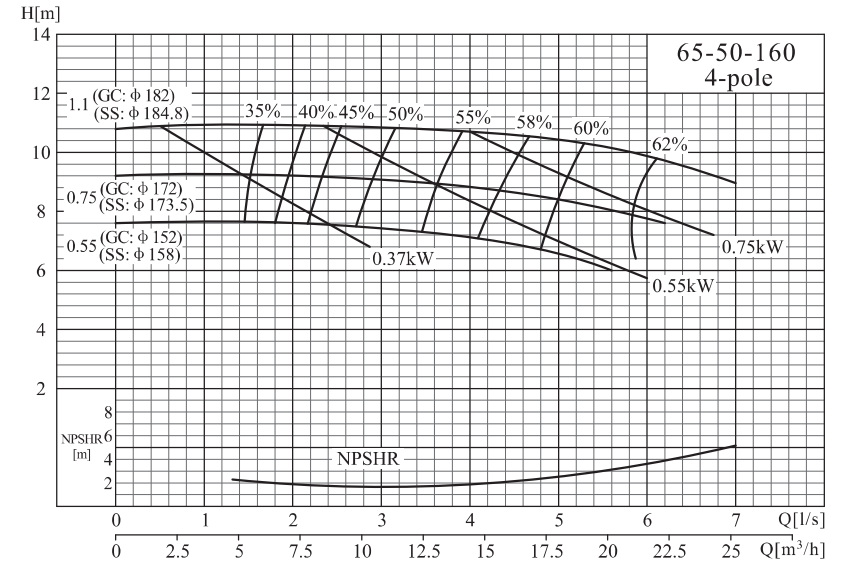

Performance curve

NISO,NIS,NISF80-50-250/80-50-315

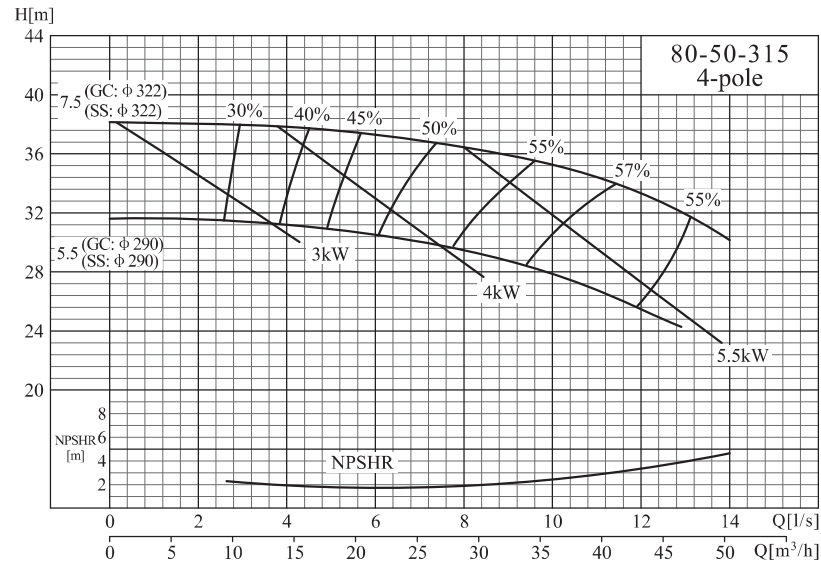
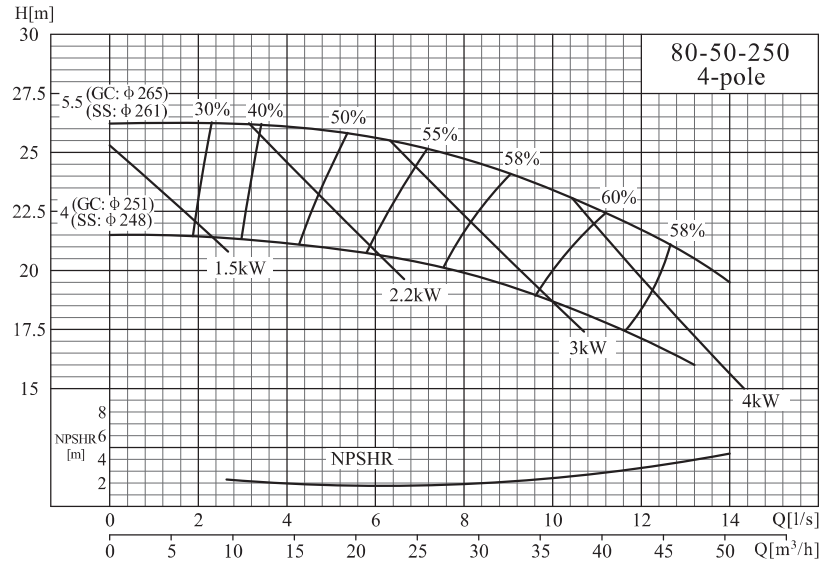

Performance curve

NISO,NIS,NISF80-65-160/100-65-200

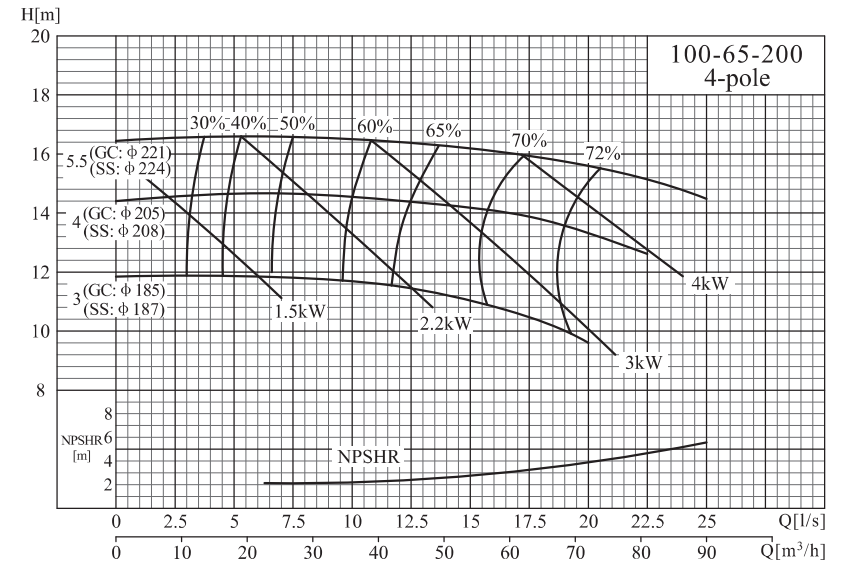
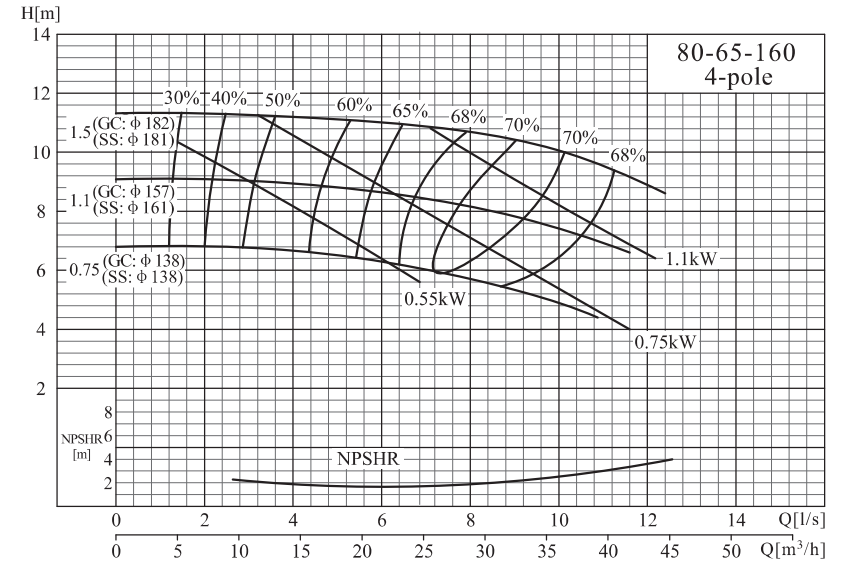

Performance curve

NISO, NIS, NISF 100-65-250/100-65-315

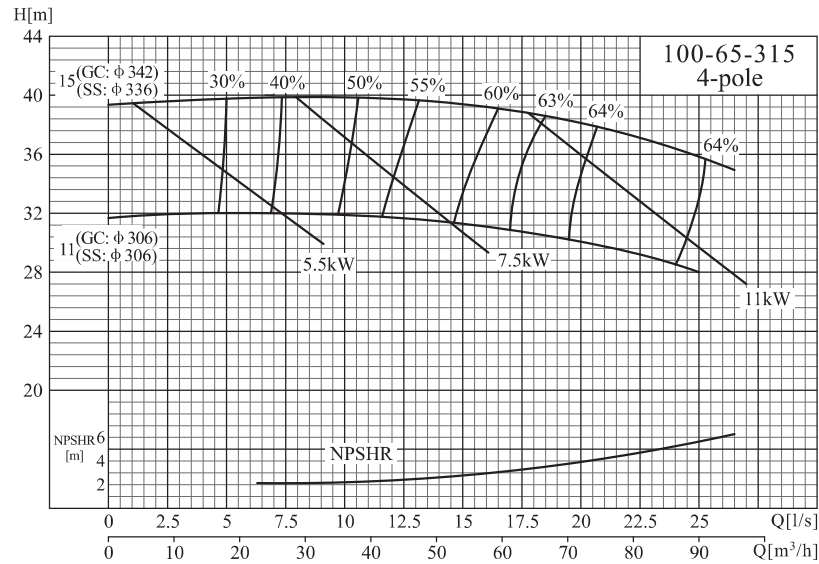
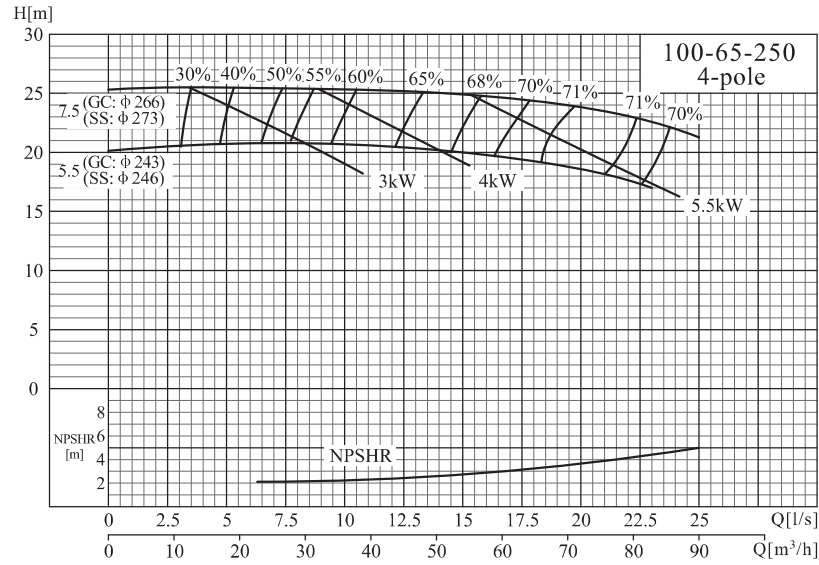

Performance curve

NISO, NIS, NISF 100-80-160/125-100-200

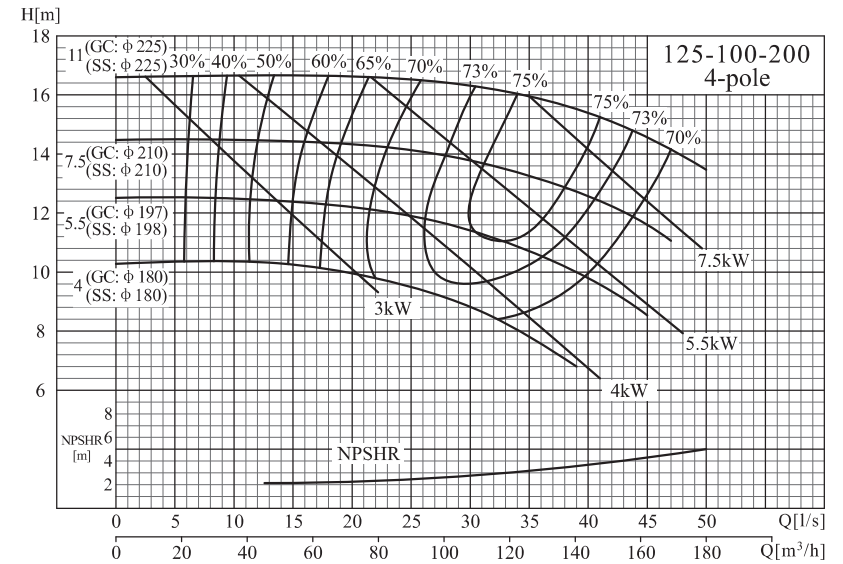
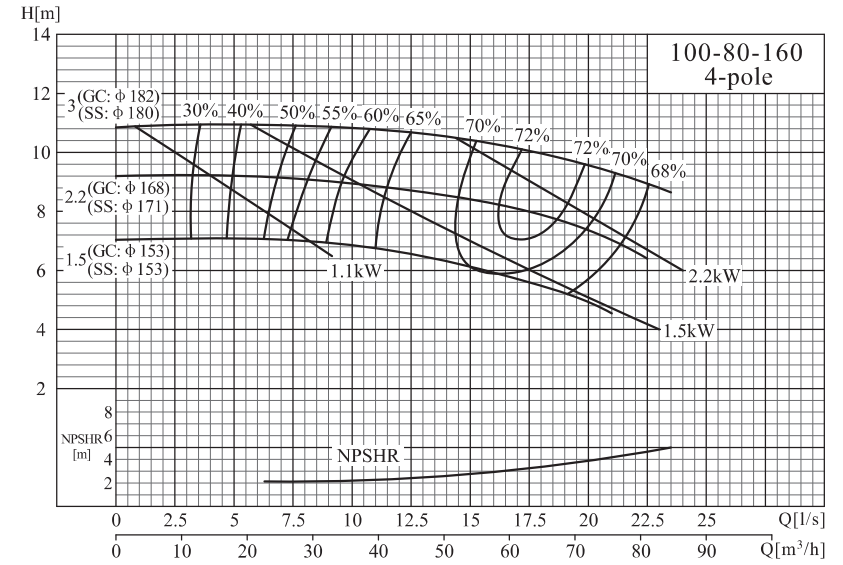

Performance curve

NISO, NIS, NISF 125-100-250/125-100-315

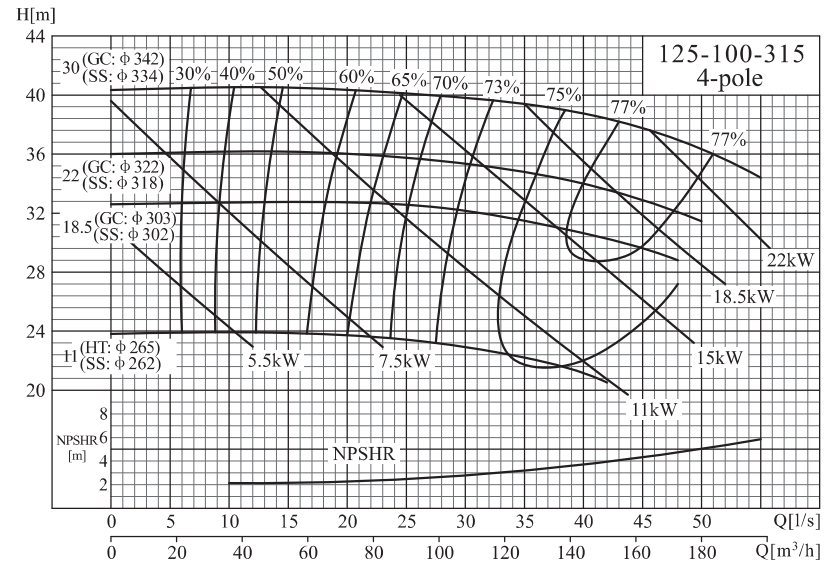
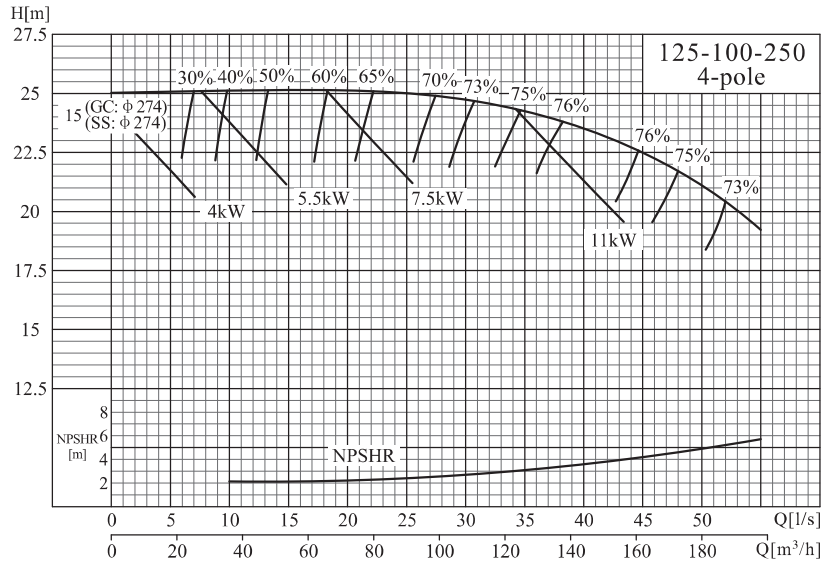

Performance curve

NISO, NIS, NISF 125-80-400/125-100-400

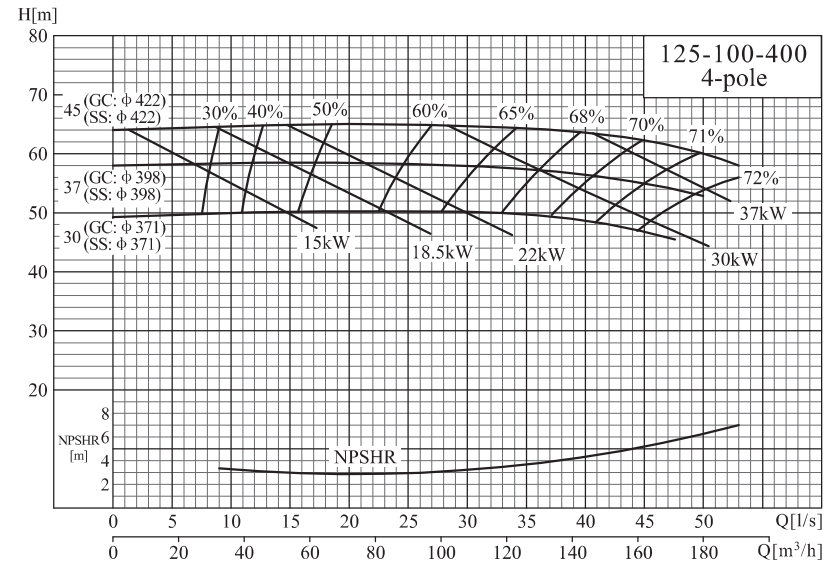
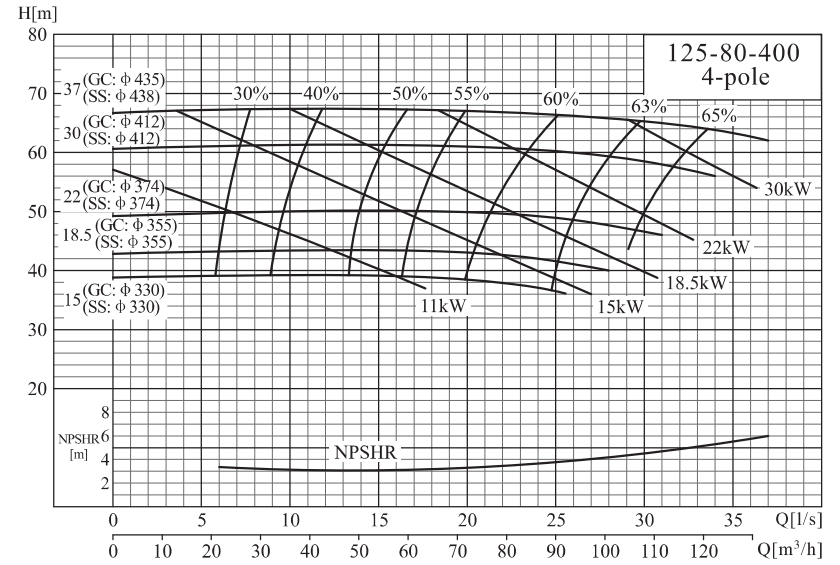

Performance curve

NISO, NIS, NISF 150-125-250/150-125-315

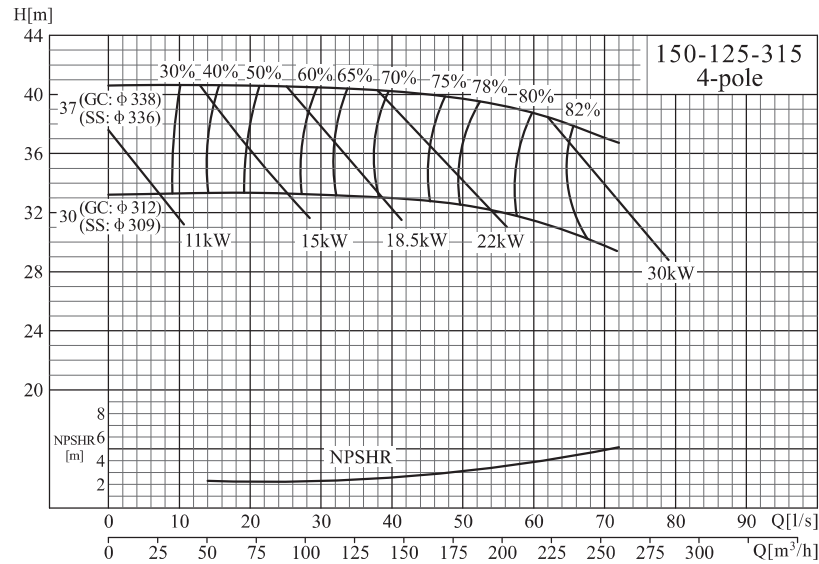
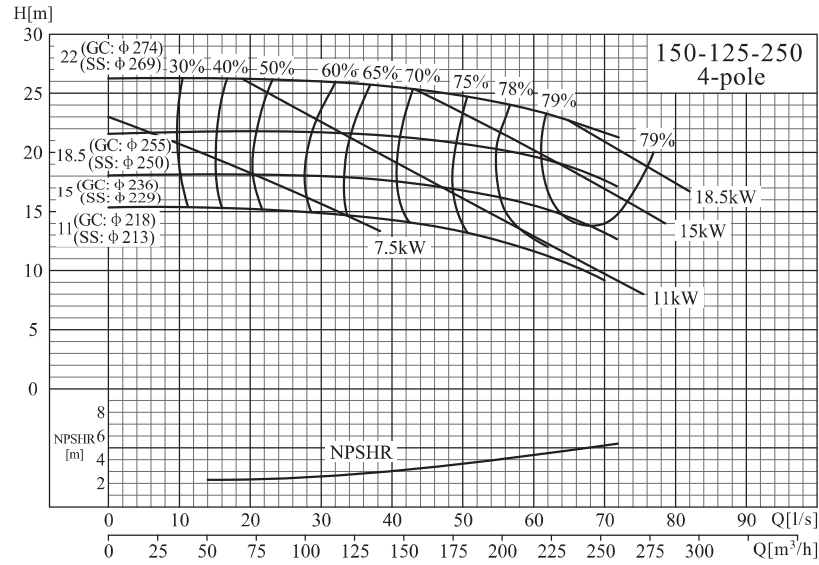

Performance curve

NISO, NIS, NISF 150-125-400/200-150-315

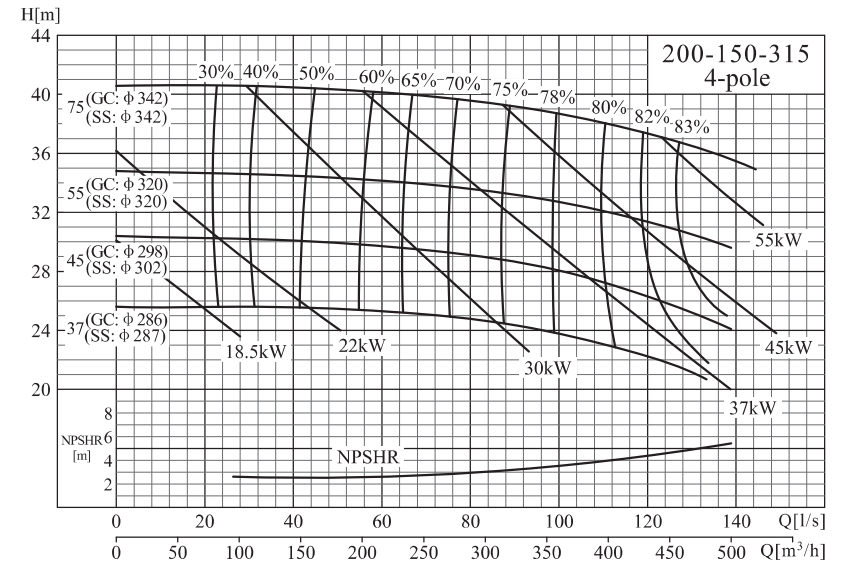
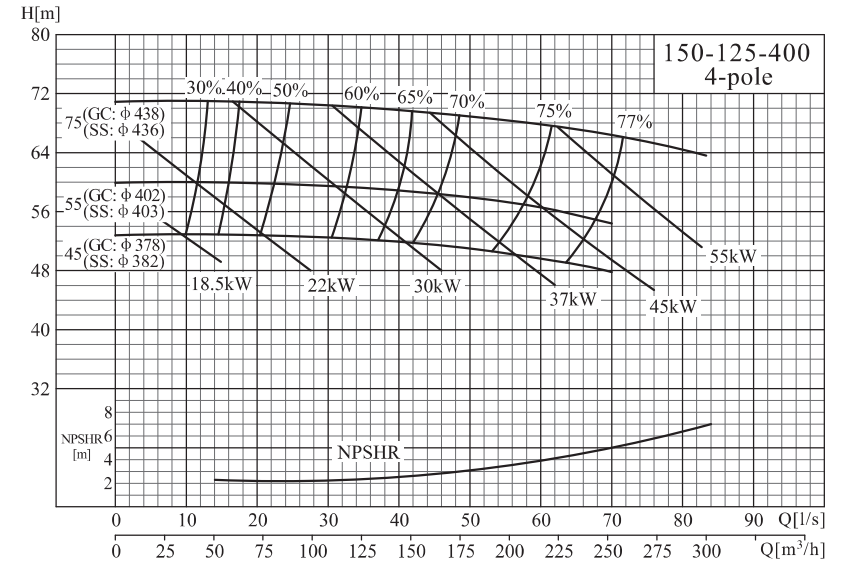

Performance curve

NISO, NIS, NISF 200-150-400/250-200-315

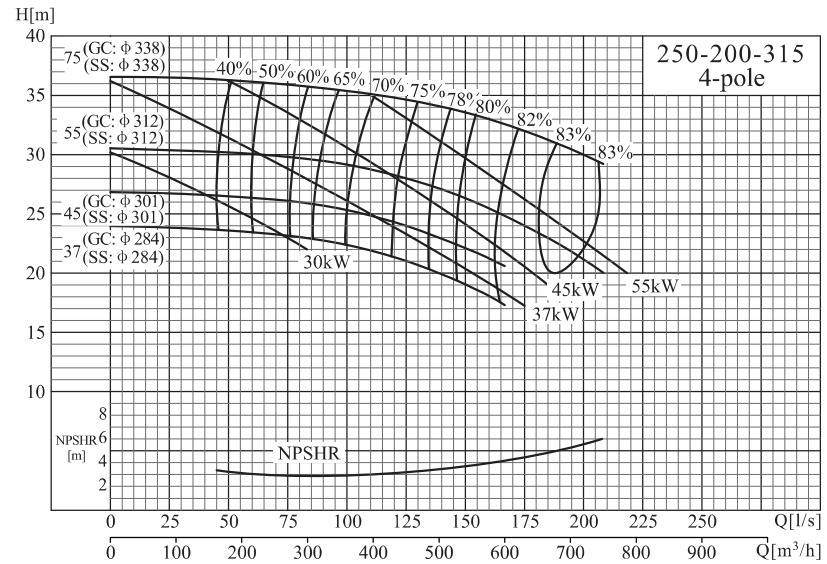
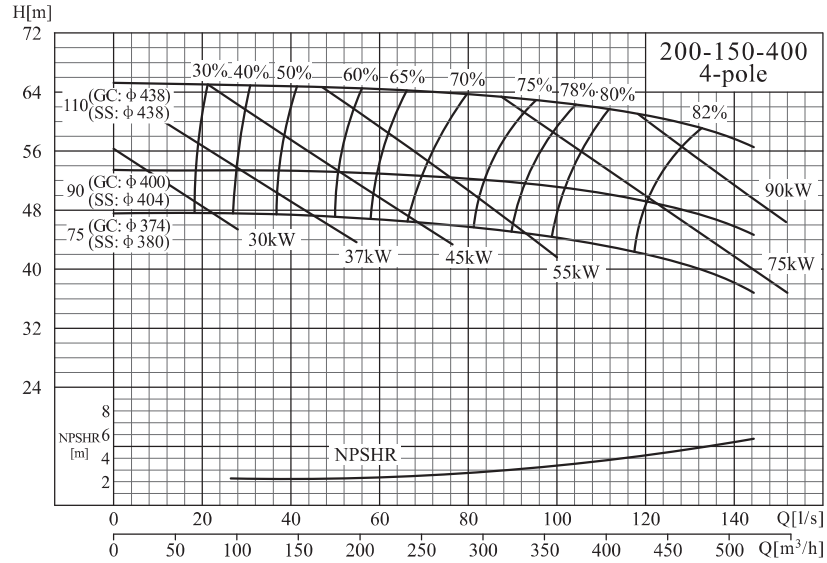

Performance curve

NISO, NIS, NISF 250-200-400/300-250-315(Q)

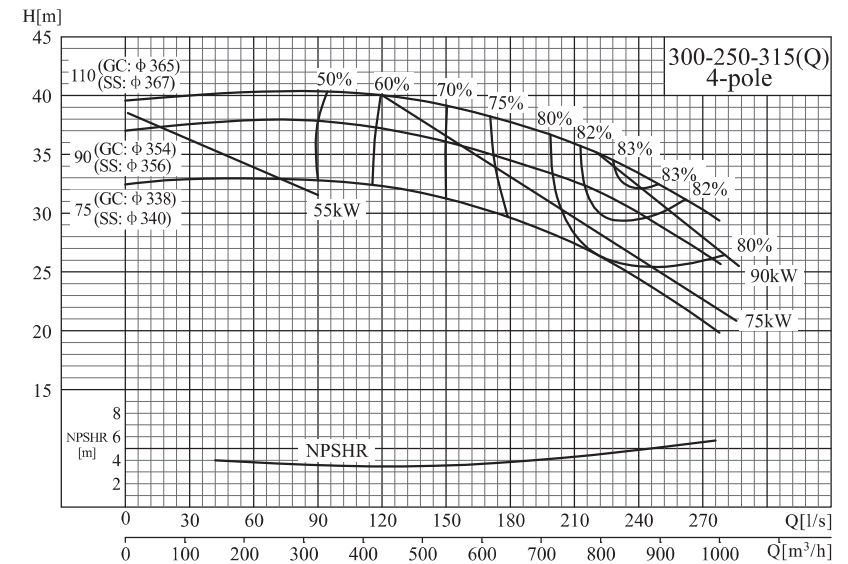
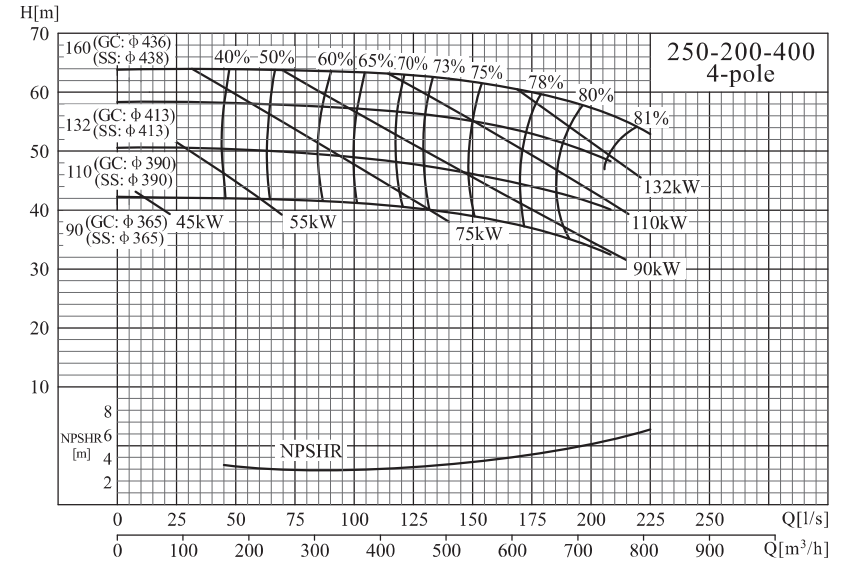

Performance curve

NISO, NIS, NISF 300-250-400(Q)/300-250-315

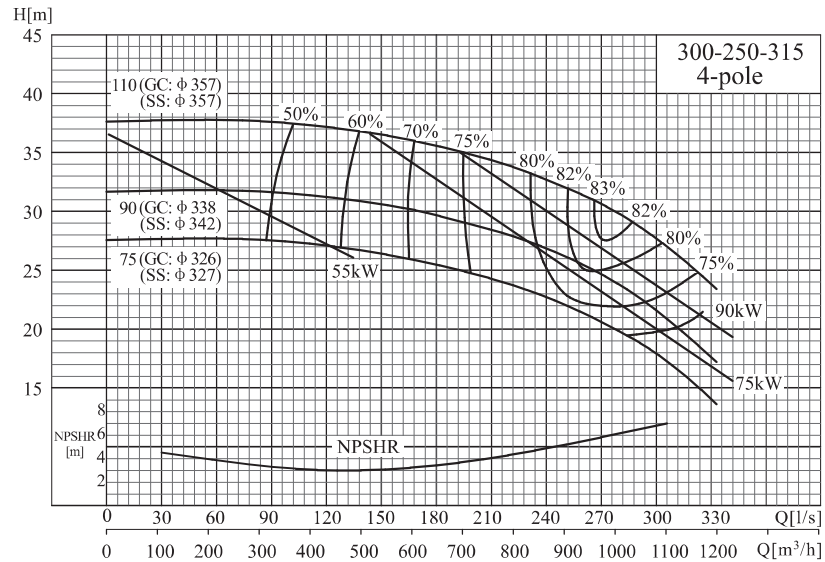
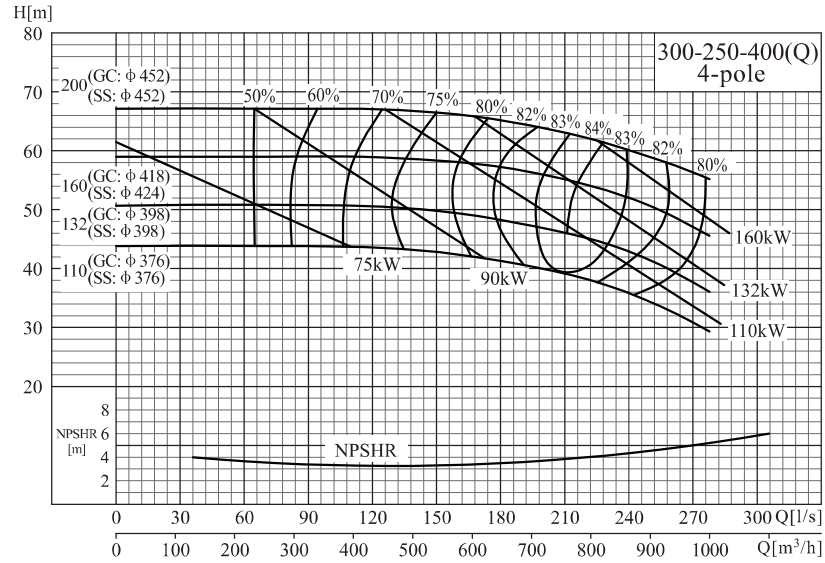

Performance curve

NISO, NIS, NISF 300-250-400

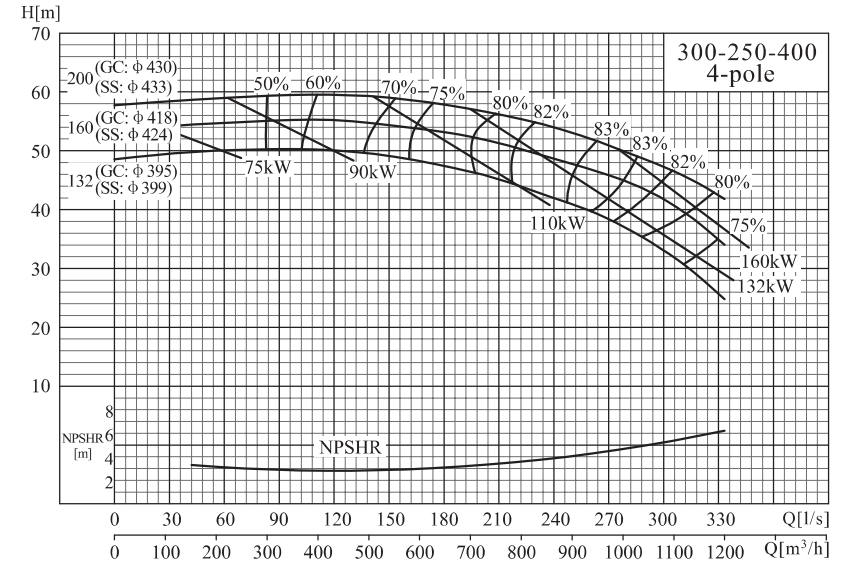

NISO dimension drawing

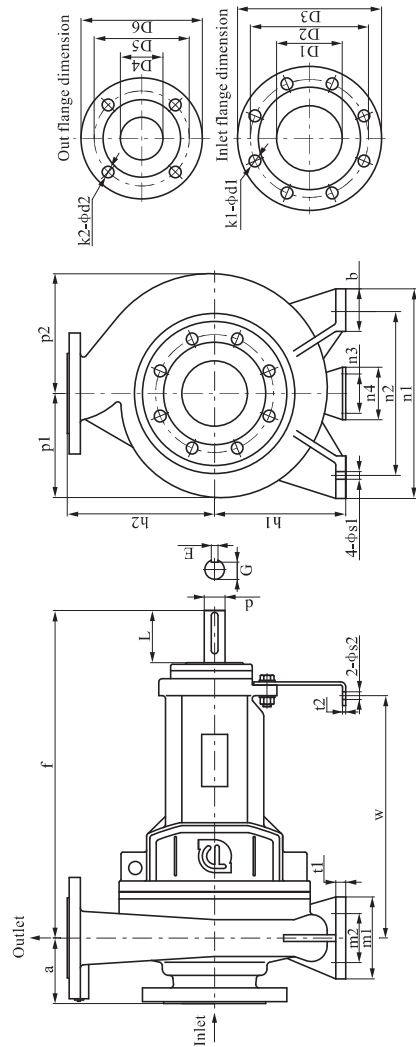

NISO dimension table

No.	Model	Dimension						Pump base plate and installation dimension											
		a	f	h1	h2	b	p1	p2	m1	m2	n1	n2	n3	n4	t1	t2	w	s1	s2
1	50-32-160	80	385	132	160	50	118	128	100	70	240	190	110	160	12	6	285	14	14
2	50-32-200	80	385	160	180	50	139	147	100	70	240	190	110	160	12	6	285	14	14
3	65-50-160	80	385	132	160	50	121	136	100	70	240	190	110	160	12	6	285	14	14
4	65-40-200	100	385	160	180	50	140	151	100	70	265	212	110	160	13	6	285	14	14
5	65-40-250	100	500	180	225	65	166	176	125	95	320	250	110	160	14	6	370	14	14
6	65-40-315	125	500	200	250	65	194	200	125	95	345	280	110	160	16	6	370	14	14
7	80-65-160	100	385	160	180	50	124	143	100	70	265	212	110	160	13	6	285	14	14
8	80-50-200	100	385	160	200	52	147	161	100	70	265	212	110	160	13	6	285	14	14
9	80-50-250	125	500	180	225	65	167	179	125	95	320	250	110	160	15	6	370	14	14
10	80-50-315	125	500	225	280	65	204	215	125	95	345	280	110	160	18	6	370	14	14
11	100-65-200	100	500	180	225	65	159	183	125	95	320	250	110	160	14	6	370	14	14
12	100-65-250	125	500	200	250	80	180	201	160	120	360	280	110	160	16	6	370	18	14
13	100-65-315	125	530	225	280	80	210	228	160	120	400	315	110	160	18	6	370	18	14
14	100-80-160	100	500	160	200	65	132	160	125	95	280	212	110	160	14	6	370	14	14
15	125-80-400	125	530	280	355	80	261	279	160	120	435	355	110	160	20	6	370	18	14
16	125-100-200	125	500	200	280	80	175	210	160	120	360	280	110	160	17	6	370	18	14
17	125-100-250	140	530	225	280	80	193	225	160	120	400	315	110	160	18	6	370	18	14
18	125-100-315	140	530	250	315	80	224	250	160	120	400	315	110	160	19	6	370	18	14
19	125-100-400	140	530	280	355	100	265	287	200	150	500	400	110	160	20	6	370	18	14
20	150-125-250	140	530	250	355	80	204	244	160	120	400	315	110	160	19	6	370	18	14
21	150-125-315	140	530	280	355	100	236	271	200	150	500	400	110	160	20	6	370	22	14
22	150-125-400	140	530	315	400	100	273	301	200	150	500	400	110	160	21	6	370	22	14
23	200-150-315	160	670	315	400	82	255	304	200	150	515	450	140	180	25	10	500	22	18
24	200-150-400	160	670	315	450	82	291	330	200	150	515	450	140	180	25	10	500	22	18
25	250-200-315	180	670	315	450	82	278	344	200	150	515	450	140	180	25	10	500	22	18
26	250-200-400	180	670	380	450	82	314	367	200	150	515	450	140	180	25	10	500	22	18
27	300-250-315(Q)	225	698	375	455	120	303	381	300	250	710	600	140	180	25	10	528	28	18
28	300-250-400(Q)	225	676	425	500	120	328	395	300	250	710	600	140	180	25	12	506	28	18
29	300-250-315	225	698	375	455	120	303	381	300	250	710	600	140	180	25	10	528	28	18
30	300-250-400	225	676	425	500	120	328	395	300	250	710	600	140	180	25	12	506	28	18

NISO dimension table

No.	Model	Inlet flange dimension					Outlet flange dimension					Shaft extension dimension				Weight (kg)
		D1	D2	D3	k1	d1	D4	D5	D6	k2	d2	D	L	E	G	
1	50-32-160	50	125	165	4	18	32	100	140	4	18	24	50	8	20	38
2	50-32-200	50	125	165	4	18	32	100	140	4	18	24	50	8	20	43
3	65-50-160	65	145	185	4	18	50	125	165	4	18	24	50	8	20	41
4	65-40-200	65	145	185	4	18	40	110	150	4	18	24	50	8	20	45
5	65-40-250	65	145	185	4	18	40	110	150	4	18	32	80	10	27	68
6	65-40-315	65	145	185	4	18	40	110	150	4	18	32	80	10	27	84
7	80-65-160	80	160	200	8	18	65	145	185	4	18	24	50	8	20	44
8	80-50-200	80	160	200	8	18	50	125	165	4	18	24	50	8	20	48
9	80-50-250	80	160	200	8	18	50	125	165	4	18	32	80	10	27	71
10	80-50-315	80	160	200	8	18	50	125	165	4	18	32	80	10	27	90
11	100-65-200	100	180	220	8	18	65	145	185	4	18	32	80	10	27	67
12	100-65-250	100	180	220	8	18	65	145	185	4	18	32	80	10	27	82
13	100-65-315	100	180	220	8	18	65	145	185	4	18	42	110	12	37	120
14	100-80-160	100	180	220	8	18	80	160	200	8	18	32	80	10	27	70
15	125-80-400	125	210	250	8	18	80	160	200	8	18	42	110	12	37	158
16	125-100-200	125	210	250	8	18	100	180	220	8	18	32	80	10	27	88
17	125-100-250	125	210	250	8	18	100	180	220	8	18	42	110	12	37	122
18	125-100-315	125	210	250	8	18	100	180	220	8	18	42	110	12	37	137
19	125-100-400	125	210	250	8	18	100	180	220	8	18	42	110	12	37	163
20	150-125-250	150	240	285	8	22	125	210	250	8	18	42	106	12	37	129
21	150-125-315	150	240	285	8	22	125	210	250	8	18	42	106	12	37	157
22	150-125-400	150	240	285	8	22	125	210	250	8	18	42	106	12	37	181
23	200-150-315	200	295	340	12	22	150	240	285	8	22	60	110	18	53	222
24	200-150-400	200	295	340	12	22	150	240	285	8	22	60	110	18	53	293
25	250-200-315	250	355	405	12	26	200	295	340	12	22	60	110	18	53	258
26	250-200-400	250	355	405	12	26	200	295	340	12	22	60	110	18	53	328
27	300-250-315(Q)	300	410	460	12	27	250	355	405	12	27	60	108	18	53	528
28	300-250-400(Q)	300	410	460	12	27	250	355	405	12	27	60	108	18	53	632
29	300-250-315	300	410	460	12	27	250	355	405	12	27	60	108	18	53	528
30	300-250-400	300	410	460	12	27	250	355	405	12	27	60	108	18	53	632

NISO pump set dimension drawing

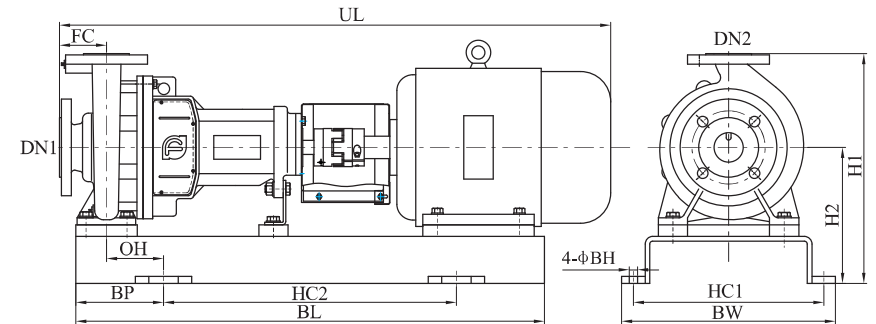

NISO pump set dimension table

Model	Power (kW)													2-pole	
		H1	H2	HC1	HC2	BW	BL	BP	BH	OH	UL	FC	DN1	DN2	Total weight (kg)
50-32-160	3	392	232	296	500	336	750	125	14	72.5	857	80	50	32	95
	4	392	232	296	500	336	750	125	14	72.5	875	80	50	32	109
	5.5	392	232	325	500	365	800	150	14	97.5	941	80	50	32	133
50-32-200	7.5	440	243	340	600	380	860	130	14	77.5	941	80	50	32	146
	11	440	260	380	600	420	950	175	18	121	1077	80	50	32	190
65-40-200	7.5	440	260	325	500	365	800	150	14	97.5	961	100	65	40	145
	11	440	260	380	600	420	950	175	18	121	1097	100	65	40	192
	15	440	260	380	600	420	950	175	18	121	1097	100	65	40	208
65-40-250	18.5	505	280	380	800	420	1080	140	18	73.5	1282	100	65	40	255
	22	505	280	420	800	480	1100	150	18	81.5	1319	100	65	40	291
	30	525	300	460	800	500	1180	190	18	121.5	1379	100	65	40	363
65-40-315	22	550	300	420	800	460	1100	150	18	81.5	1344	125	65	40	307
	30	570	320	455	800	495	1200	200	18	131.5	1412	125	65	40	392
	37	570	320	455	800	495	1200	200	18	131.5	1412	125	65	40	403
	45	590	340	510	800	560	1250	225	22	155	1466	125	65	40	453
65-50-160	4	392	232	296	500	336	750	125	14	72.5	875	80	65	50	112
	5.5	392	232	325	500	365	800	150	14	97.5	941	80	65	50	135
	7.5	392	232	325	500	365	800	150	14	97.5	941	80	65	50	141

NISO pump set dimension table

															2-pole
Model	Power (kW)	H1	H2	HC1	HC2	BW	BL	BP	BH	OH	UL	FC	DN1	DN2	Total weight (kg)
80-50-200	11	460	260	380	600	420	950	175	18	121	1097	100	80	50	194
	15	460	260	380	600	420	950	175	18	121	1097	100	80	50	210
	18.5	460	260	380	600	420	950	175	18	121	1137	100	80	50	222
	22	480	280	420	700	460	1000	150	18	96	1194	100	80	50	268
80-50-250	30	525	300	460	800	500	1180	190	18	121.5	1404	125	80	50	367
	37	525	300	460	800	495	1180	190	18	121.5	1404	125	80	50	377
80-50-315	37	625	345	455	800	495	1200	200	18	131.5	1402	125	80	50	410
	45	625	345	510	800	560	1250	225	22	155	1466	125	80	50	451
	55	650	370	575	900	625	1300	200	22	130	1547	125	80	50	573
80-65-160	75	680	400	620	800	670	1400	300	22	230	1620	125	80	50	703
	5.5	440	260	325	500	365	800	150	14	97.5	961	100	80	65	139
	7.5	440	260	325	500	365	800	150	14	97.5	961	100	80	65	144
	11	440	260	380	600	420	950	175	18	121	1097	100	80	65	191
100-65-200	15	440	260	380	600	420	950	175	18	121	1097	100	80	65	206
	18.5	505	280	380	800	420	1080	140	18	73.5	1282	100	100	65	254
	22	505	280	420	800	460	1100	150	18	81.5	1319	100	100	65	290
	30	525	300	460	800	500	1180	190	18	121.5	1379	100	100	65	362
100-65-250	37	525	300	460	800	500	1180	190	18	121.5	1379	100	100	65	372
	45	590	340	510	800	550	1250	225	22	141.5	1466	125	100	65	444
	55	620	370	575	900	625	1350	225	22	141.5	1547	125	100	65	576
100-65-315	75	650	400	620	800	670	1400	300	22	214	1620	125	100	65	695
	90	680	400	620	900	670	1450	275	22	189	1700	125	100	65	771
	110	720	440	710	1000	760	1500	250	22	164	1909	125	100	65	1278
100-80-160	11	460	260	380	800	420	1080	140	18	73.5	1212	100	100	80	221
	15	460	260	380	800	420	1080	140	18	73.5	1212	100	100	80	237
	18.5	460	260	380	800	420	1080	140	18	73.5	1282	100	100	80	253
	22	480	280	420	800	460	1100	150	18	83.5	1319	100	100	80	293
125-100-200	30	600	320	455	800	495	1200	200	18	119	1412	125	125	100	390
	37	600	320	455	800	495	1200	200	18	119	1412	125	125	100	400
	45	620	340	510	800	560	1250	225	22	141.5	1466	125	125	100	449
	55	650	370	575	900	625	1350	225	22	141.5	1547	125	125	100	580
	75	680	400	620	800	670	1400	300	22	214	1620	125	125	100	699

NISO pump set dimension table

																	2-pole
Model	Power (kW)	H1	H2	HC1	HC2	BW	BL	BP	BH	OH	UL	FC	DN1	DN2	Total weight (kg)		
125-100-250	75	680	400	620	800	670	1400	300	22	214	1665	140	125	100	734		
	90	680	400	620	900	670	1450	275	22	189	1715	140	125	100	774		
	110	720	440	710	1000	760	1500	250	22	164	1924	140	125	100	1278		
125-100-315	90	715	400	620	900	670	1450	275	22	189	1715	140	125	100	784		
	110	755	440	710	1000	760	1500	250	22	164	1909	140	125	100	1238		
	132	755	440	710	1000	760	1560	280	22	194	2034	140	125	100	1344		
	160	755	440	710	1000	760	1560	280	22	194	2034	140	125	100	1441		

																	4-pole
Model	Power (kW)	H1	H2	HC1	HC2	BW	BL	BP	BH	OH	UL	FC	DN1	DN2	Total weight (kg)		
50-32-160	0.55	392	232	296	500	336	700	100	14	47.5	755	80	50	32	78		
	0.75	392	232	296	500	336	700	100	14	47.5	755	80	50	32	79		
50-32-200	1.1	440	260	296	500	336	750	125	14	72.5	794	80	50	32	89		
	1.5	440	260	296	500	336	750	125	14	72.5	819	80	50	32	91		
65-40-200	1.1	440	260	325	500	365	750	125	14	72.5	824	100	65	40	92		
	1.5	440	260	325	500	365	750	125	14	72.5	849	100	65	40	94		
	2.2	440	260	325	500	365	750	125	14	72.5	887	100	65	40	107		
65-40-250	3	505	280	376	600	416	920	160	14	95	992	100	65	40	141		
65-40-315	4	550	300	405	600	445	900	150	14	85	1045	125	65	40	171		
	5.5	550	300	405	600	445	950	175	14	110	1101	125	65	40	192		
65-50-160	0.55	392	232	296	500	336	700	100	14	47.5	755	80	65	50	81		
	0.75	392	232	296	500	336	700	100	14	47.5	755	80	65	50	81		
	1.1	392	232	296	500	336	700	100	14	47.5	794	80	65	50	85		
80-50-200	1.5	460	260	325	500	365	750	125	14	72.5	849	100	80	50	96		
	2.2	460	260	325	500	365	750	125	14	72.5	877	100	80	50	109		
	3	460	260	325	500	365	750	125	14	72.5	877	100	80	50	113		
80-50-250	4	505	280	376	600	416	920	160	14	95	1042	125	80	50	155		
	5.5	505	280	376	600	416	920	160	14	95	1107	125	80	50	173		
80-50-315	5.5	605	325	405	600	445	950	175	18	108.5	1101	125	80	50	199		
	7.5	605	325	405	600	445	950	175	18	108.5	1141	125	80	50	211		
80-65-160	0.75	440	260	325	500	365	700	100	14	47.5	775	100	80	65	84		
	1.1	440	260	325	500	365	750	125	14	72.5	824	100	80	65	91		
	1.5	440	260	325	500	365	750	125	14	72.5	849	100	80	65	93		

NISO pump set dimension table

															4-pole
Model	Power (kW)	H1	H2	HC1	HC2	BW	BL	BP	BH	OH	UL	FC	DN1	DN2	Total weight (kg)
100-65-200	3	505	280	376	600	416	920	160	14	95	992	100	100	65	140
	4	505	280	376	600	416	920	160	14	95	1017	100	100	65	150
	5.5	505	280	376	600	416	920	160	14	95	1082	100	100	65	169
100-65-250	5.5	550	300	420	600	460	980	190	14	110	1111	125	100	65	190
	7.5	550	300	420	600	460	980	190	18	110	1151	125	100	65	203
100-65-315	11	605	325	460	800	500	1120	160	18	80	1267	125	100	65	298
	15	605	325	460	800	500	1120	160	18	80	1307	125	100	65	312
100-80-160	1.5	460	260	340	600	380	860	130	14	65	954	100	100	80	124
	2.2	460	260	340	600	380	860	130	14	65	982	100	100	80	135
	3	460	260	340	600	380	860	130	14	65	982	100	100	80	139
125-80-400	15	735	380	500	800	540	1150	175	18	94	1317	125	125	80	362
	18.5	735	380	500	800	540	1150	175	18	94	1374	125	125	80	381
	22	735	380	510	800	560	1220	210	22	126.5	1404	125	125	80	418
	30	735	380	510	800	560	1220	210	22	126.5	1442	125	125	80	474
125-100-200	37	755	400	510	800	560	1250	225	22	141.5	1481	125	125	80	548
	4	580	300	420	600	460	900	150	14	70	1045	125	125	100	171
	5.5	580	300	420	600	460	980	190	18	110	1111	125	125	100	195
125-100-250	7.5	580	300	420	600	460	980	190	18	110	1151	125	125	100	207
	11	580	300	420	800	460	1100	150	18	70	1237	125	125	100	263
	15	605	325	460	800	500	1120	160	18	80	1322	140	125	100	312
125-100-315	11	665	350	460	800	500	1120	160	18	79	1282	140	125	100	314
	18.5	665	350	460	800	500	1180	190	18	109	1379	140	125	100	354
	22	665	350	460	800	500	1180	190	18	109	1409	140	125	100	380
125-100-400	30	665	350	510	800	560	1220	210	22	126.5	1457	140	125	100	452
	30	735	380	570	800	620	1220	210	22	110	1447	140	125	100	478
	37	755	400	575	900	625	1300	200	22	100	1496	140	125	100	552
150-125-250	45	755	400	575	900	625	1300	200	22	100	1531	140	125	100	581
	11	705	350	460	800	500	1120	160	18	79	1282	140	150	125	309
	15	705	350	460	800	500	1120	160	18	79	1322	140	150	125	324
150-125-400	18.5	705	350	460	800	500	1180	190	18	109	1379	140	150	125	349
	22	705	350	460	800	500	1180	190	18	109	1409	140	150	125	375

NISO pump set dimension table

																		4-pole
Model	Power (kW)	H1	H2	HC1	HC2	BW	BL	BP	BH	OH	UL	FC	DN1	DN2	Total weight (kg)			
150-125-315	30	735	380	570	800	620	1220	210	22	110	1447	140	150	125	483			
	37	755	400	575	900	625	1300	200	22	100	1496	140	150	125	559			
150-125-400	45	835	435	575	900	625	1300	200	22	100	1531	140	150	125	607			
	55	835	435	575	900	625	1350	225	22	125	1592	140	150	125	709			
	75	835	435	620	800	670	1400	300	22	200	1665	140	150	125	844			
200-150-315	37	835	435	620	800	670	1400	300	22	200	1656	160	200	150	628			
	45	835	435	595	900	645	1500	300	22	200	1691	160	200	150	659			
	55	835	435	595	900	645	1500	300	22	200	1752	160	200	150	762			
	75	835	435	625	1000	675	1600	300	22	200	1835	160	200	150	903			
200-150-400	75	885	435	625	1000	675	1600	300	22	200	1835	160	200	150	973			
	90	885	435	625	1000	675	1600	300	22	200	1885	160	200	150	1024			
	110	885	435	710	1200	760	1700	250	22	150	2124	160	200	150	1467			
250-200-315	37	885	435	620	800	670	1400	300	22	200	1676	180	250	200	663			
	45	885	435	595	900	645	1500	300	22	200	1711	180	250	200	694			
	55	885	435	595	900	645	1500	300	22	200	1772	180	250	200	798			
250-200-400	75	885	435	625	1000	675	1600	300	22	200	1855	180	250	200	943			
	90	950	500	625	1000	675	1600	300	22	200	1905	180	250	200	1075			
	110	950	500	710	1200	760	1700	250	22	150	2144	180	250	200	1524			
300-250-315(Q)	132	950	500	710	1200	760	1750	275	22	175	2244	180	250	200	1606			
	160	950	500	710	1200	760	1750	275	22	175	2244	180	250	200	1710			
	75	950	495	800	1150	850	1700	275	22	125	1933	225	300	250	1525			
300-250-400(Q)	90	950	495	800	1150	850	1700	275	22	125	1983	225	300	250	1603			
	110	950	495	800	1250	850	1800	275	22	125	2228	225	300	250	1931			
	110	1045	545	800	1250	850	1800	275	22	125	2206	225	300	250	1980			
300-250-315	132	1045	545	800	1330	850	1880	275	22	125	2236	225	300	250	2085			
	160	1045	545	800	1330	850	1880	275	22	125	2236	225	300	250	2145			
	200	1045	545	800	1330	850	1880	275	22	125	2236	225	300	250	2260			
300-250-400	75	950	495	800	1150	850	1700	275	22	125	1933	225	300	250	1525			
	90	950	495	800	1150	850	1700	275	22	125	1983	225	300	250	1603			
	110	950	495	800	1250	850	1800	275	22	125	2228	225	300	250	1931			

NISO pump set dimension table

4-pole

Model	Power (kW)	H1	H2	HC1	HC2	BW	BL	BP	BH	OH	UL	FC	DN1	DN2	Total weight (kg)
300-250-400	132	1045	545	800	1330	850	1880	275	22	125	2236	225	300	250	2085
	160	1045	545	800	1330	850	1880	275	22	125	2236	225	300	250	2145
	200	1045	545	800	1330	850	1880	275	22	125	2236	225	300	250	2260

NIS, NISF pump dimension drawing

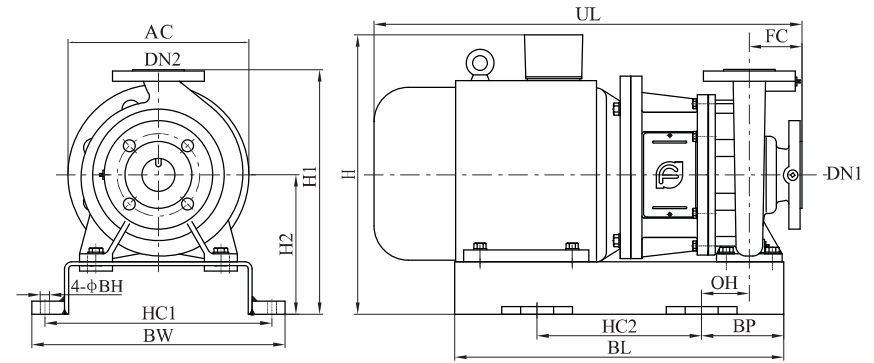

NIS, NISF pump dimension table

2-pole

Model	Power (kW)	H	H1	H2	HC1	HC2	BW	BL	BP	BH	OH	UL	FC	DN1	DN2	Total weight (kg)
50-32-160	3	382	372	212	306	250	336	450	100	14	47.5	563	80	50	32	75
	4	400	372	212	306	250	336	450	100	14	47.5	578	80	50	32	81
	5.5	425	372	212	335	300	365	500	100	14	47.5	650	80	50	32	105
50-32-200	7.5	453	420	240	350	300	380	500	100	14	46	650	80	50	32	120
	11	500	420	240	390	350	420	600	125	18	71	787	80	50	32	175
65-40-200	7.5	453	420	240	335	300	365	500	100	14	47.5	670	100	65	40	120
	11	500	420	240	390	350	420	600	125	18	71	807	100	65	40	177
	15	500	420	240	390	350	420	600	125	18	71	807	100	65	40	187
65-40-250	18.5	520	485	260	390	400	420	660	130	18	63.5	865	100	65	40	222
	22	535	485	260	430	400	460	700	150	18	81.5	895	100	65	40	257
	30	585	505	280	470	450	500	750	150	18	81.5	967	100	65	40	318
65-40-315	22	555	530	280	430	400	460	700	150	18	81.5	920	125	65	40	270
	30	585	530	280	465	500	495	800	150	18	81.5	992	125	65	40	340
	37	585	530	280	465	500	495	800	150	18	81.5	992	125	65	40	359
	45	640	555	305	520	500	560	820	160	22	90	1042	125	65	40	428
65-50-160	4	400	372	212	306	250	336	450	100	14	47.5	578	80	65	50	83
	5.5	425	372	212	335	300	365	500	100	14	47.5	650	80	65	50	107
	7.5	425	372	212	335	300	365	500	100	14	47.5	650	80	65	50	110

NIS, NISF pump dimension table

2-pole																
Model	Power (kW)	H	H1	H2	HC1	HC2	BW	BL	BP	BH	OH	UL	FC	DN1	DN2	Total weight (kg)
80-50-200	11	500	440	240	390	350	420	600	125	18	71	807	100	80	50	181
	15	500	440	240	390	350	420	600	125	18	71	807	100	80	50	191
	18.5	500	440	240	390	400	420	660	130	18	76	862	100	80	50	211
	22	535	460	260	430	400	460	700	150	18	96	892	100	80	50	254
80-50-250	30	585	505	280	470	450	500	750	150	18	81.5	992	125	80	50	320
	37	585	505	280	470	450	500	750	150	18	81.5	992	125	80	50	339
80-50-315	37	610	585	305	465	500	495	800	150	18	81.5	992	125	80	50	370
	45	640	585	305	520	500	560	820	160	22	90	1042	125	80	50	434
	55	715	630	350	585	550	625	950	200	22	130	1156	125	80	50	534
80-65-160	5.5	453	420	240	335	300	365	500	100	14	47.5	670	100	80	65	115
	7.5	453	420	240	335	300	365	500	100	14	47.5	670	100	80	65	118
	11	500	420	240	390	350	420	600	125	18	71	807	100	80	65	175
	15	500	420	240	390	350	420	600	125	18	71	807	100	80	65	185
100-65-200	18.5	520	485	260	390	400	420	660	130	18	63.5	865	100	100	65	222
	22	535	485	260	430	400	460	700	150	18	81.5	895	100	100	65	257
	30	585	505	280	470	450	500	750	150	18	81.5	967	100	100	65	318
	37	585	505	280	470	450	500	750	150	18	81.5	967	100	100	65	337
100-65-250	45	640	555	305	520	500	560	820	160	22	76.5	1042	125	100	65	426
	55	715	600	350	585	550	625	950	200	22	116.5	1156	125	100	65	529
	75	780	630	380	630	600	670	1000	200	22	114	1231	125	100	65	673
100-65-315	90	780	660	380	630	600	670	1100	250	22	164	1295	125	100	65	730
	110	945	695	415	720	600	760	1100	250	22	164	1530	125	100	65	1161
100-80-160	11	515	440	240	390	400	420	660	130	18	61.5	810	100	100	80	177
	15	515	440	240	390	400	420	660	130	18	61.5	810	100	100	80	187
	18.5	515	440	240	390	400	420	660	130	18	61.5	865	100	100	80	207
	22	535	460	260	430	400	460	700	150	18	83.5	895	100	100	80	248
125-100-200	30	585	560	280	465	500	495	800	150	18	69	992	125	125	100	349
	37	585	560	280	465	500	495	800	150	18	69	992	125	125	100	368
	45	640	585	305	520	500	560	820	160	22	76.5	1042	125	125	100	431
	55	715	630	350	585	550	625	950	200	22	116.5	1156	125	125	100	534
75	780	660	380	630	600	670	1000	200	22	114	1231	125	125	100	678	

NIS, NISF pump dimension table

2-pole																	
Model	Power (kW)	H	H1	H2	HC1	HC2	BW	BL	BP	BH	OH	UL	FC	DN1	DN2	Total weight (kg)	
125-100-250	75	780	660	380	630	600	670	1000	200	22	114	1265	140	125	100	701	
	90	780	660	380	630	600	670	1100	250	22	164	1315	140	125	100	738	
	110	945	695	415	720	600	760	1100	250	22	164	1523	140	125	100	1169	
125-100-315	90	780	695	380	630	600	670	1100	250	22	164	1310	140	125	100	744	
	110	945	730	415	720	600	760	1100	250	22	164	1545	140	125	100	1170	
	132	945	730	415	720	700	760	1220	260	22	174	1655	140	125	100	1230	
	160	945	730	415	720	700	760	1220	260	22	174	1655	140	125	100	1350	

4-pole																	
Model	Power (kW)	H	H1	H2	HC1	HC2	BW	BL	BP	BH	OH	UL	FC	DN1	DN2	Total weight (kg)	
50-32-160	0.55	352	372	212	306	250	336	400	75	14	22.5	483	80	50	32	44	
	0.75	352	372	212	306	250	336	400	75	14	22.5	483	80	50	32	45	
50-32-200	1.1	400	420	240	306	250	336	400	75	14	22.5	498	80	50	32	71	
	1.5	400	420	240	306	250	336	400	75	14	22.5	523	80	50	32	78	
65-40-200	1.1	400	420	240	335	250	365	400	75	14	22.5	518	100	65	40	73	
	1.5	400	420	240	335	250	365	400	75	14	22.5	543	100	65	40	80	
	2.2	410	420	240	335	250	365	450	100	14	47.5	583	100	65	40	91	
65-40-250	3	430	485	260	386	300	416	500	100	14	35	591	100	65	40	109	
	4	468	530	280	415	300	445	500	100	14	35	631	125	65	40	128	
65-40-315	5.5	493	530	280	415	300	445	500	100	14	35	687	125	65	40	151	
	0.55	352	372	212	306	250	336	400	75	14	22.5	483	80	65	50	46	
65-50-160	0.75	352	372	212	306	250	336	400	75	14	22.5	483	80	65	50	47	
	1.1	372	372	212	306	250	336	400	75	14	22.5	498	80	65	50	63	
80-50-200	1.5	400	440	240	335	250	365	400	75	14	22.5	543	100	80	50	84	
	2.2	410	440	240	335	250	365	450	100	14	47.5	583	100	80	50	95	
	3	410	440	240	335	250	365	450	100	14	47.5	583	100	80	50	100	
80-50-250	4	448	485	260	386	300	416	500	100	14	35	631	125	80	50	116	
	5.5	473	485	260	386	300	416	500	100	14	35	687	125	80	50	137	
80-50-315	5.5	518	585	305	415	350	445	550	100	18	33.5	687	125	80	50	155	
	7.5	518	585	305	415	350	445	550	100	18	33.5	727	125	80	50	169	
80-65-160	0.75	380	420	240	335	250	365	400	75	14	22.5	503	100	80	65	67	
	1.1	400	420	240	335	250	365	400	75	14	22.5	518	100	80	65	71	
	1.5	400	420	240	335	250	365	400	75	14	22.5	543	100	80	65	78	

NIS, NISF pump dimension table

																4-pole
Model	Power (kW)	H	H1	H2	HC1	HC2	BW	BL	BP	BH	OH	UL	FC	DN1	DN2	Total weight (kg)
100-65-200	3	430	485	260	386	300	416	500	100	14	35	591	100	100	65	109
	4	448	485	260	386	300	416	500	100	14	35	606	100	100	65	114
	5.5	473	485	260	386	300	416	500	100	14	35	662	100	100	65	135
100-65-250	5.5	493	530	280	430	350	460	550	100	14	20	687	125	100	65	147
	7.5	493	530	280	430	350	460	550	100	18	20	727	125	100	65	166
100-65-315	11	565	585	305	470	400	500	700	150	18	70	854	125	100	65	249
	15	565	585	305	470	400	500	700	150	18	70	909	125	100	65	270
100-80-160	1.5	400	440	240	350	250	380	410	105	14	40	536	100	100	80	76
	2.2	410	440	240	350	300	380	500	100	14	35	591	100	100	80	87
	3	410	440	240	350	300	380	500	100	14	35	591	100	100	80	92
125-80-400	15	620	715	360	510	450	540	750	150	18	68	911	125	125	80	334
	18.5	635	715	360	510	450	540	750	150	18	66.5	941	125	125	80	369
	22	635	715	360	520	450	560	750	150	22	76.5	981	125	125	80	391
	30	665	715	360	520	500	560	820	160	22	68	1015	125	125	80	440
	37	695	715	360	520	500	560	820	160	22	76.5	1058	125	125	80	498
125-100-200	4	468	560	280	430	300	460	500	100	14	20	631	125	125	100	136
	5.5	493	560	280	430	350	460	550	100	18	20	687	125	125	100	152
	7.5	493	560	280	430	350	460	550	100	18	20	727	125	125	100	171
	11	540	560	280	430	400	460	650	125	18	45	835	125	125	100	222
125-100-250	15	565	585	305	470	400	500	700	150	18	70	924	140	125	100	278
125-100-315	11	590	645	330	470	400	500	700	150	18	69	869	140	125	100	261
	18.5	605	645	330	470	450	500	750	150	18	69	954	140	125	100	317
	22	605	645	330	470	450	500	750	150	18	69	994	140	125	100	335
	30	635	645	330	520	500	560	820	160	22	76.5	1028	140	125	100	394
125-100-400	30	665	715	360	580	500	620	800	150	22	50	1028	140	125	100	444
	37	715	735	380	585	550	625	950	200	22	100	1071	140	125	100	523
	45	715	735	380	585	550	625	950	200	22	100	1101	140	125	100	552
150-125-250	11	590	685	330	470	400	500	700	150	18	69	869	140	150	125	257
	15	590	685	330	470	400	500	700	150	18	69	924	140	150	125	284
	18.5	605	685	330	470	450	500	750	150	18	69	954	140	150	125	315
	22	605	685	330	470	450	500	750	150	18	69	994	140	150	125	333

NIS, NISF pump dimension table

																		4-pole
Model	Power (kW)	H	H1	H2	HC1	HC2	BW	BL	BP	BH	OH	UL	FC	DN1	DN2	Total weight (kg)		
150-125-315	30	665	715	360	580	500	620	800	150	22	50	1028	140	150	125	430		
	37	715	735	380	585	550	625	950	200	22	100	1071	140	150	125	507		
150-125-400	45	750	815	415	585	550	625	950	200	22	100	1103	140	150	125	561		
	55	780	815	415	585	550	625	950	200	22	100	1187	140	150	125	620		
200-150-315	75	815	815	415	630	600	670	1000	200	22	100	1262	140	150	125	776		
	37	750	815	415	605	600	670	900	200	22	100	1116	160	200	150	541		
	45	750	815	415	605	500	645	900	200	22	100	1146	160	200	150	579		
200-150-400	55	780	815	415	605	600	645	1000	200	22	100	1254	160	200	150	650		
	75	815	815	415	630	600	675	1100	250	22	150	1329	160	200	150	806		
	75	815	865	415	630	600	675	1100	250	22	150	1329	160	200	150	859		
250-200-315	90	815	865	415	630	600	675	1100	250	22	150	1379	160	200	150	956		
	110	945	865	415	720	700	760	1220	260	22	160	1614	160	200	150	1325		
	37	750	865	415	605	500	670	900	200	22	100	1136	180	250	200	592		
250-200-400	45	750	865	415	605	500	645	900	200	22	100	1166	180	250	200	630		
	55	780	865	415	605	600	645	1100	250	22	150	1274	180	250	200	695		
	75	815	865	415	630	600	675	1100	250	22	150	1349	180	250	200	840		
	90	845	930	480	630	600	675	1100	250	22	150	1399	180	250	200	1015		
300-250-315(Q)	110	1010	930	480	720	750	760	1250	250	22	150	1634	180	250	200	1400		
	132	1010	930	480	720	700	760	1220	260	22	160	1744	180	250	200	1495		
	160	1010	930	480	720	700	760	1220	260	22	160	1744	180	250	200	1564		
	75	930	930	475	810	750	850	1250	250	22	90	1356	225	300	250	1120		
300-250-400(Q)	90	930	930	475	810	750	850	1250	250	22	90	1406	225	300	250	1182		
	110	1005	930	475	810	750	850	1250	250	22	90	1743	225	300	250	1518		
	110	1055	1025	525	810	750	850	1250	250	22	90	1611	225	300	250	1582		
300-250-315	132	1055	1025	525	810	900	850	1400	250	22	90	1721	225	300	250	1676		
	160	1055	1025	525	810	900	850	1400	250	22	90	1721	225	300	250	1777		
	200	1055	1025	525	810	900	850	1400	250	22	90	1721	225	300	250	1853		
	75	930	930	475	810	750	850	1250	250	22	90	1356	225	300	250	1120		
300-250-400	90	930	930	475	810	750	850	1250	250	22	90	1406	225	300	250	1182		
	110	1005	930	475	810	750	850	1250	250	22	90	1743	225	300	250	1518		
	132	1055	1025	525	810	900	850	1400	250	22	90	1721	225	300	250	1676		
	160	1055	1025	525	810	900	850	1400	250	22	90	1721	225	300	250	1777		
300-250-400	200	1055	1025	525	810	900	850	1400	250	22	90	1721	225	300	250	1853		

Note: Flange dimension of NIS,NISF series are the same with NISO series.