



# SJ

50Hz

Stainless Steel Multistage

Deep-Well Submersible Pump



REPRESENTATIVE IN GEORGIA

Address: Tbilisi; Libani street 2

Tel: +995 032 248 35 62

Email: [info@cnp.ge](mailto:info@cnp.ge)

Website: [cnp.ge](http://cnp.ge)



E220805  
subject to amendments



Stock code:300145

Pumping Water Pumping Honor



## Company profile

Nanfang Pump Industry Co., Ltd (CNP), as a subsidiary of Nanfang Zhongjin Environment Co., Ltd, was founded in 1991, and listed on Shenzhen Stock Exchange on December 9, 2010 with stock code 300145.

In 2019, CNP's annual output exceeded 900,000 units/set with nearly 3 billion sales revenue, continuing to maintain high growth. As a national enterprise technology center, CNP has flagship ultra-high efficient product -new generation CDM (F) light vertical multistage centrifugal pump,  $MEI \geq 0.7$ . Same series high temperature pump products are developed in 2019 to satisfy high temperature applications. All light stainless steel pump product series grow stably. Advanced frequency conversion water supply equipment has been innovated to the 6th generation. Fire pump and diesel engine have obtained UL certification. TD in-line pump, NIS/NISO end suction pump, NSC split casing pump, WQ sewage pump, PQ stainless steel fountain submersible pump, BP silent tube pump, pool pump, non-blocking self-priming sewage pump, metering pump, oil pump and other pump products, can meet various application needs of different fields.

CNP has a complete sales network both in domestic and overseas market, exporting to over 60 countries and regions, maintaining long <g> relationship with our clients. CNP pumps have been widely applied in various fields like water treatment, water supply and drainage, HVAC, industrial application, seawater desalination, energy and power etc.

CNP, a green water expert beside you.

## Content

### General Data

Performance scope	3
Product range	3
Typical applications	4
Operation conditions	4
NEMA Motor	4
Definition of model	4
Curve conditions	4
Performance curve	4
Material	5

### Technical Data

SJ1,50Hz	6
SJ3,50Hz	8
SJ5,50Hz	10
SJ8,50Hz	12
SJ12,50Hz	14
SJ17,50Hz	16
SJ30,50Hz	18
SJ42,50Hz	20
SJ60,50Hz	22
SJ75,50Hz	24
SJ95,50Hz	26
SJ120,50Hz	28
SJ150,50Hz	30
SJ200,50Hz	32

### Performance scope

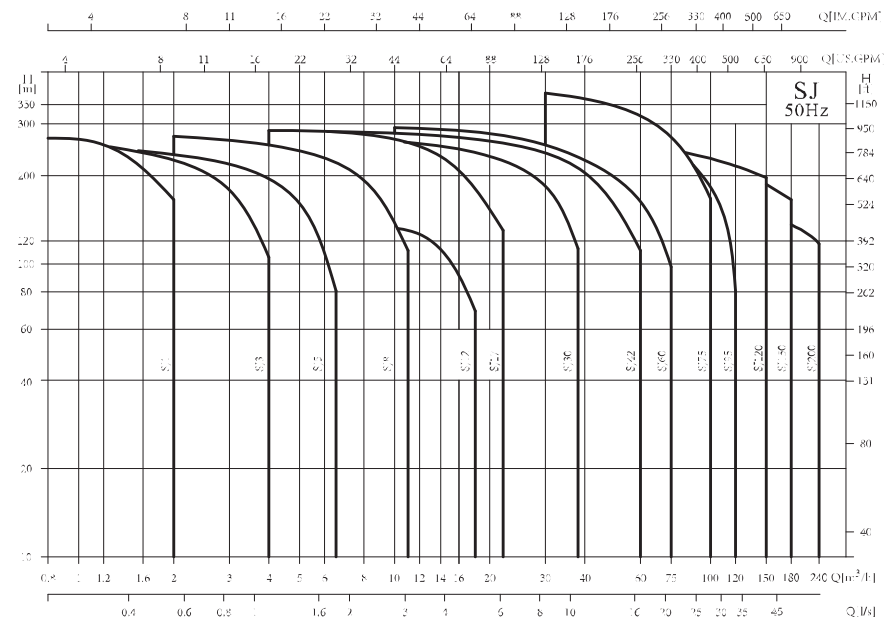

### Product range

Description	SJ1	SJ3	SJ5	SJ8	SJ12	SJ17	SJ30	SJ42	SJ60	SJ75	SJ95	SJ120	SJ150	SJ200
50Hz														
Rated flow [m <sup>3</sup> /h]	1	3	5	8	12	17	30	42	60	75	95	120	150	200
Rated flow [l/s]	0.28	0.83	1.39	2.22	3.33	4.72	8.33	11.7	16.7	20.8	26.4	33.3	41.6	55.6
Flow range [m <sup>3</sup> /h]	0.2~2	0.8~4	1~6.5	2~11	3~18	4~22	5~38	5~60	10~75	30~100	40~120	60~150	80~180	100~240
Flow range [l/s]	0.06~0.56	0.22~1.1	0.28~1.8	0.56~3.1	0.83~5	1.11~6.1	1.39~10.6	1.39~16.7	2.8~20.8	8.3~27.8	11.1~33.3	16.6~41.6	22.2~50	27.8~66.7
Max pressure [bar]	28	25	24	27	16	26	28	28	29	38	34	25	23	16
Motor power [kW]	0.37~2.2	0.37~3	0.37~4	0.75~7.5	1.5~7.5	0.55~15	1.1~22	1.1~37	2.2~37	7.5~75	9.2~75	11~110	9.2~110	30~110
Max efficiency [%]	45	56	59	60	60	73	74	75	79	79	80	77	77	79
Pipe screw joint	Rp1 <sup>1</sup> / <sub>4</sub>	Rp1 <sup>1</sup> / <sub>4</sub>	Rp1 <sup>1</sup> / <sub>2</sub>	Rp2	Rp2	Rp2 <sup>1</sup> / <sub>2</sub>	Rp3	Rp3	Rp4	Rp5	Rp5	Rp6	Rp6	Rp6

## Typical applications

- Circulation or boosting for clean water, demineralized water.
- Water supply, irrigating system.
- Lowering ground water level.
- Boosting.
- Other industrial applications.

## Operation conditions

- Clean, thin, non-corrosive liquid without grain or fiber.
- Maximum liquid temperature: 25°C
- Maximum working pressure: 38 bar
- pH: 6.5~8.5
- Maximum diving depth: ≤70m
- For the sake of pump running safely and reliably, user shall install the correct motor protector.

## NEMA Motor

- 4" Motor Stainless steel (there is bronze flange or ss flange), oil-filled motor (transformer oil is standard configuration, but coolant oil which in accord with the standard of FDA is also available)  
Single phase: 0.37kW~2.2kW  
Three phase: 0.37kW~7.5 kW
- 6" Motor Cast iron (Standard), Stainless steel (If required, need to specify) Three phase: 4kW~37 kW
- 8" Motor Cast iron (Standard), Stainless steel (If required, need to specify) Three phase: 5.5kW~110 kW

## Definition of Model

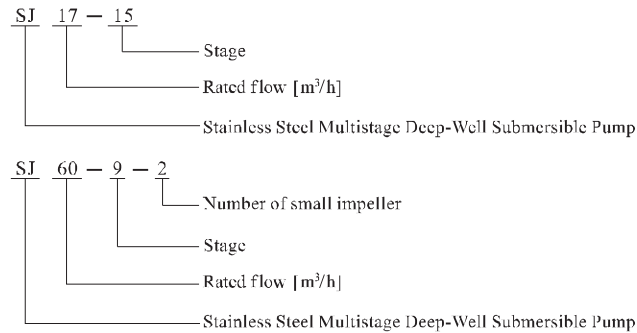

## Curve conditions

- Curve tolerance in conformity to ISO9906:2012 Grade 3B.
- All curves are based on the measured values of 50Hz: constant motor speed 2850r/min or 2900r/min.
- All measurements are carried out with gas-free water of temperature 20°C. The curve is applicable to kinematical viscosity 1mm²/s. In case density of the liquid conveyed by the pump is higher than that of water, it is necessary to use corresponding motor of higher output power.
- The bold part of the curve means the recommended performance scope.
- The performance curve includes loss caused by check valve etc.

## Performance curve

- Q/H curve means flow and head under the rated speed.
- Power curve: P2 means input power of each stage. Curves are shown for complete (1/1) and reduced diameter (2/3) impellers.
- Efficiency curve: Eta means the stage efficiency of the pump.

## Section drawing

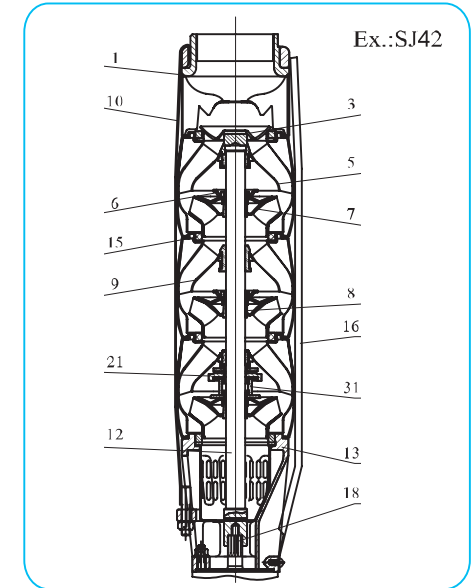
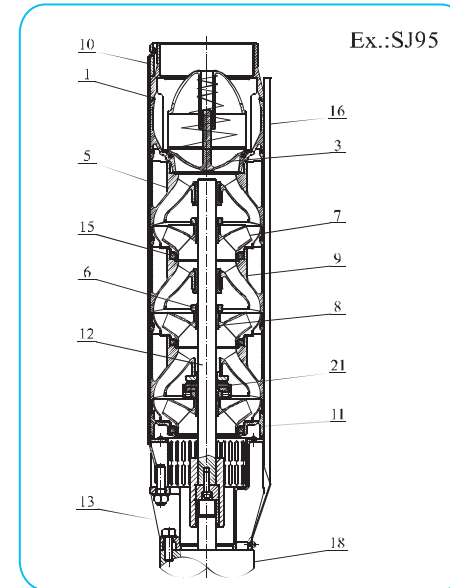
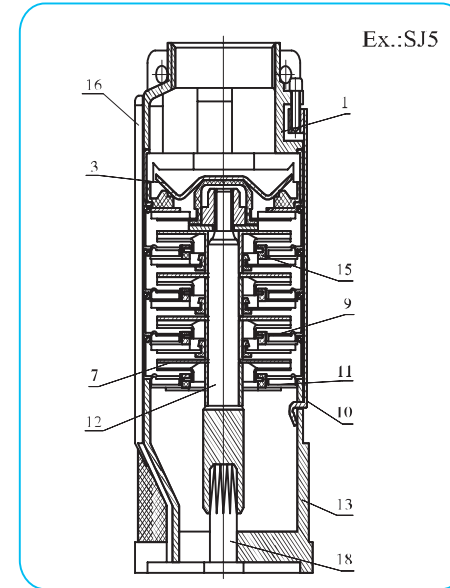

## Material

NO.	Name	Material	AISI
1	Discharge head	SS304	AISI304
3	Valve cap	SS304	AISI304
5	Discharge diffuser	SS304	AISI304
6	Impeller nut	SS304	AISI304
7	Impeller	SS304	AISI304
8	Impeller cone	SS304	AISI304
9	Diffuser	SS304	AISI304
10	Straps	SS304	AISI304
11	Inducer	SS304	AISI304
12	Pump shaft	SS304/420/431	AISI304/420/431
13	Suction Interconnector	SS304	AISI304
15	Neck ring	PBT/NBR	
16	Cable guard	SS304	AISI304
18	Submersible motor		
21	Inlet spacer	Carbon	
31	Connecting sleeve	SS304	AISI304

## Performance curve

ISO9906 Annex A 2850rpm

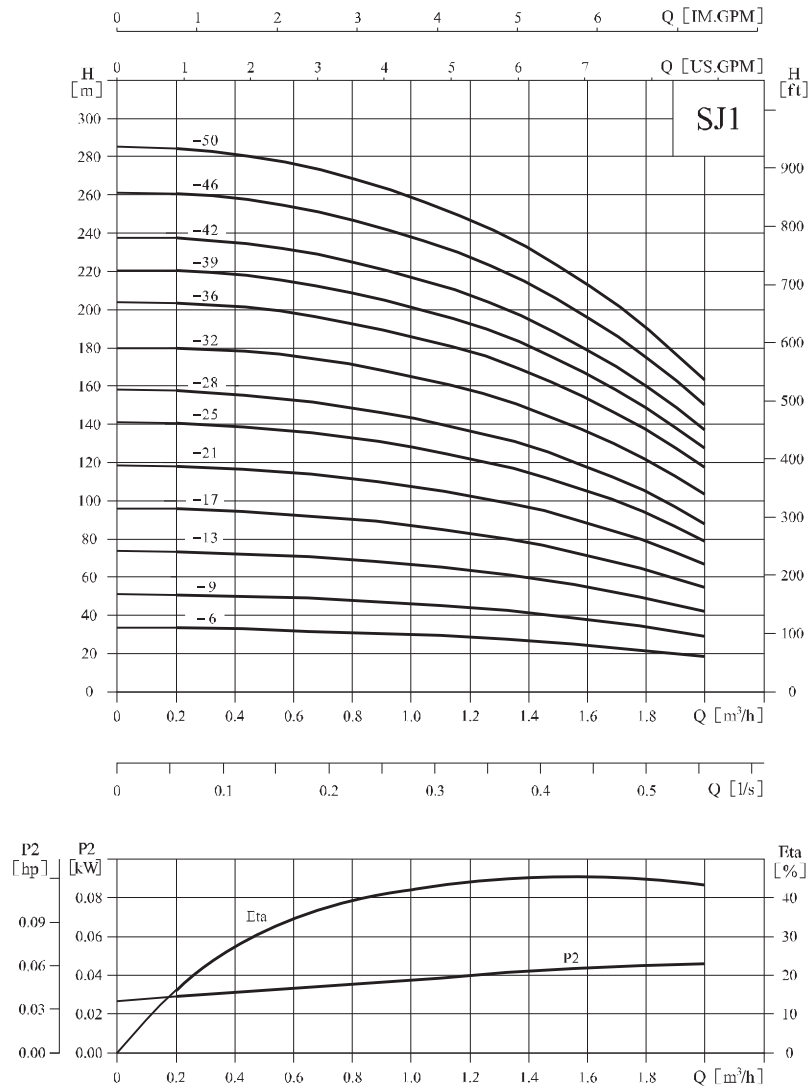

## Performance table

Model	Driving motor		Q (m <sup>3</sup> /h)	0.2	0.4	0.6	0.8	1.0	1.2	1.4	1.6	1.8	2.0
	(kW)	(hp)											
SJ1-6	0.37	0.5		33.5	33	32	31	30	29	27	25	22	19
SJ1-9	0.37	0.5		51	50	49	48	46	44	41	38	34	29
SJ1-13	0.55	0.75		73	72	71	69	67	64	60	55	49	42
SJ1-17	0.75	1		96	95	92	90	87	84	78	71	64	55
SJ1-21	1.1	1.5		119	118	115	112	108	103	97	89	80	69
SJ1-25	1.1	1.5		141	140	137	134	129	123	116	106	95	82
SJ1-28	1.5	2		158	157	153	150	145	138	130	119	107	92
SJ1-32	1.5	2		180	179	175	171	165	158	148	136	122	105
SJ1-36	1.5	2		203	202	197	192	186	178	167	153	137	118
SJ1-39	2.2	3		221	219	214	209	202	193	181	166	149	128
SJ1-42	2.2	3		238	236	230	225	217	208	195	179	160	137
SJ1-46	2.2	3		260	258	252	246	238	227	213	196	176	151
SJ1-50	2.2	3		284	282	276	269	260	248	233	214	192	165

## Installation sketch

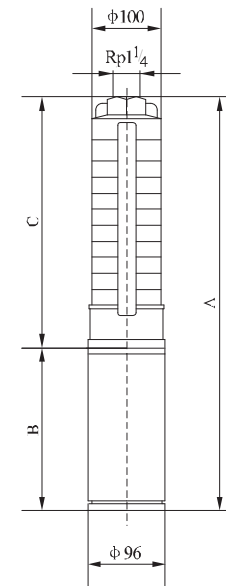

## Size and weight

Model	Size(mm)			Weight (kg)
	A	B	C	
SJ1-6	667	370	297	10
SJ1-9	730	370	360	11
SJ1-13	824	380	444	12
SJ1-17	928	400	528	15
SJ1-21	1052	440	612	16
SJ1-25	1136	440	696	17
SJ1-28	1229	470	759	20
SJ1-32	1313	470	843	21
SJ1-36	1397	470	927	22
SJ1-39	1500	510	990	24
SJ1-42	1563	510	1053	25
SJ1-46	1647	510	1137	26
SJ1-50	1731	510	1221	27

Note: The size B is varied with the motors of different manufacturers.

## Performance curve

ISO9906 Annex A 2850rpm

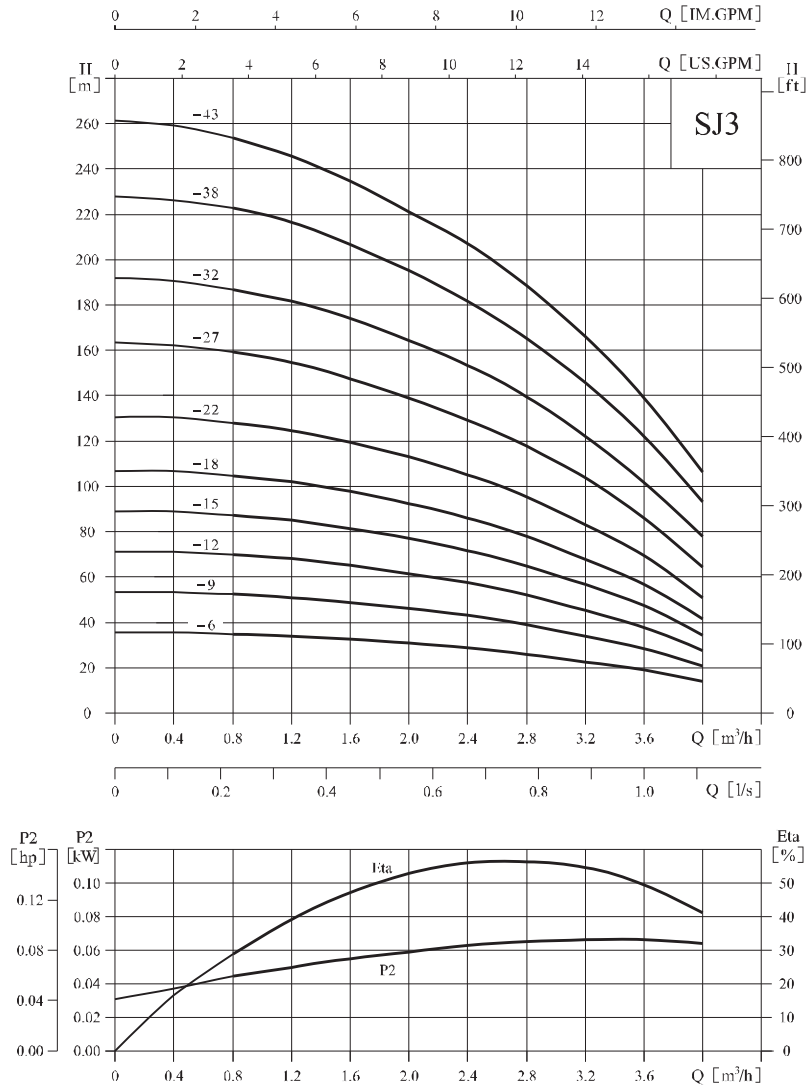

## Performance table

Model	Driving motor		Q (m³/h)	0.8	1.2	1.6	2.0	2.4	2.8	3.0	3.2	3.6	4.0
	(kW)	(hp)											
SJ3-6	0.37	0.5		36	34	32	30	28	26	24	23	18	13
SJ3-9	0.55	0.75		53	51	48	45	42	38	36	33	27	20
SJ3-12	0.75	1		70	68	64	61	57	52	49	44	37	27
SJ3-15	1.1	1.5		87	85	81	77	72	65	61	56	47	34
SJ3-18	1.1	1.5		105	103	97	92	87	78	74	68	57	42
SJ3-22	1.5	2		130	126	120	113	106	96	91	84	70	53
SJ3-27	2.2	3		159	154	146	138	130	118	111	104	87	66
SJ3-32	2.2	3		189	183	173	163	154	140	131	122	102	79
SJ3-38	3.0	4		224	217	205	194	183	168	157	146	122	94
SJ3-43	3.0	4		254	246	233	220	207	190	178	166	139	107

## Installation sketch

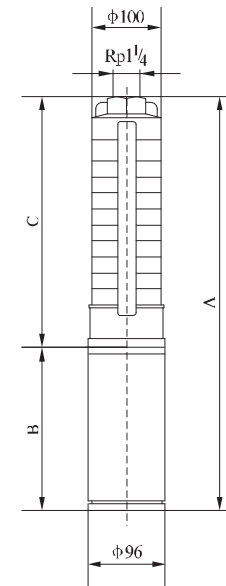

## Size and weight

Model	Size (mm)			Weight (kg)
	A	B	C	
SJ3-6	667	370	297	10
SJ3-9	740	380	360	11
SJ3-12	823	400	423	13
SJ3-15	926	440	486	15
SJ3-18	999	440	549	16
SJ3-22	1103	470	633	18
SJ3-27	1248	510	738	22
SJ3-32	1353	510	843	23
SJ3-38	1589	620	969	29
SJ3-43	1694	620	1074	30

Note: The size B is varied with the motors of different manufacturers.

## Performance curve

ISO9906 Annex A 2850rpm

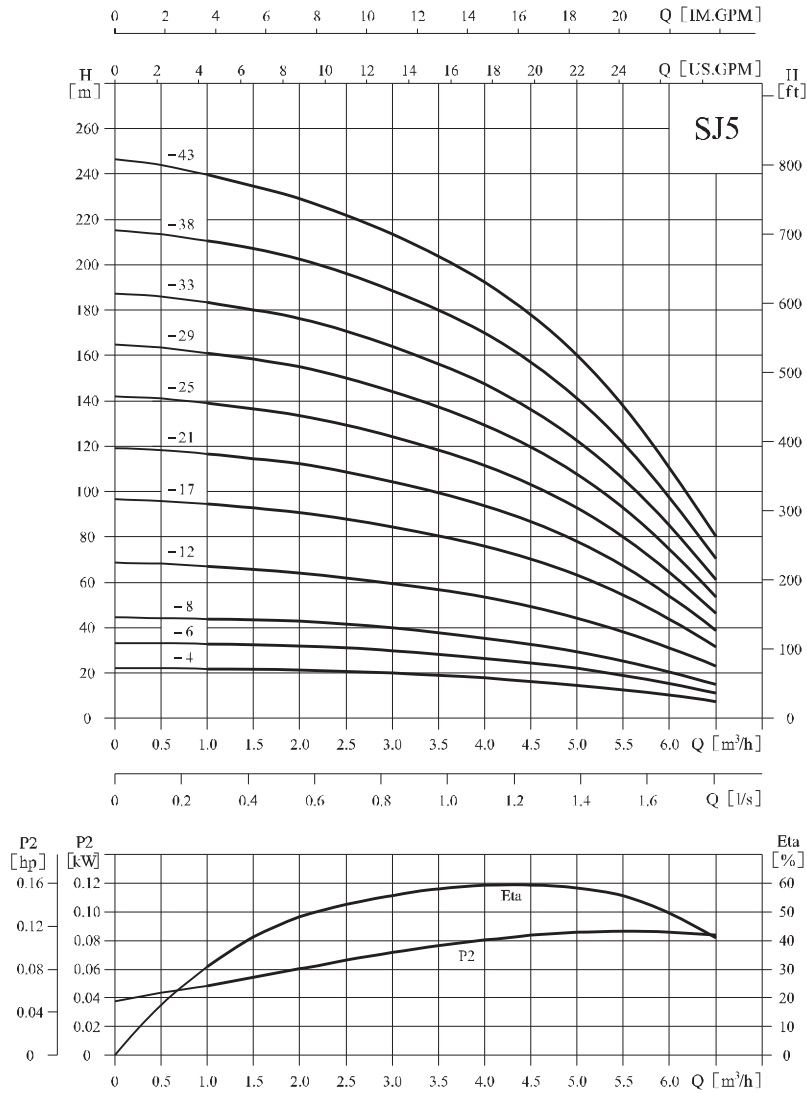

## Performance table

Model	Driving motor		Q (m³/h)	1.0	2.0	3.0	3.5	4.0	4.5	5.0	5.5	6.0	6.5
	(kW)	(hp)		H (m)									
SJ5-4	0.37	0.5		21	20.5	20	19	18	17	15	13	10	8
SJ5-6	0.55	0.75		32	31	30	28	27	25	22	19	15	11
SJ5-8	0.75	1		43	42	40	38	36	33	30	25	20	15
SJ5-12	1.1	1.5		66	63	59	57	54	50	45	38	30	23
SJ5-17	1.5	2		95	91	84	80	76	71	64	54	43	32
SJ5-21	2.2	3		117	112	104	99	94	87	79	67	53	39
SJ5-25	2.2	3		139	134	124	118	112	104	94	80	64	47
SJ5-29	3.0	4		161	155	144	137	130	120	108	92	74	55
SJ5-33	3.0	4		183	177	163	156	148	137	123	105	84	62
SJ5-38	4.0	5.5		211	203	188	178	170	158	142	121	97	71
SJ5-43	4.0	5.5		239	230	213	203	193	179	161	137	109	81

## Installation sketch

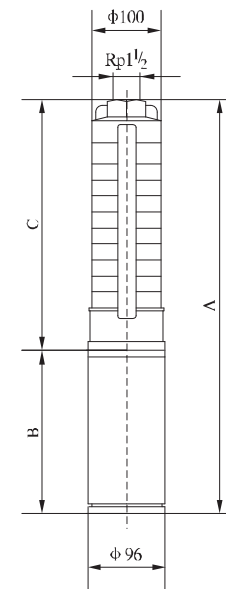

## Size and weight

Model	Size (mm)			Weight (kg)
	A	B	C	
SJ5-4	625	370	255	10
SJ5-6	677	380	297	11
SJ5-8	739	400	339	13
SJ5-12	863	440	423	14
SJ5-17	998	470	528	17
SJ5-21	1122	510	612	21
SJ5-25	1206	510	696	22
SJ5-29	1400	620	780	27
SJ5-33	1484	620	864	28
SJ5-38	1719	750	969	32
SJ5-43	1824	750	1074	33

Note: The size B is varied with the motors of different manufacturers.

## Performance curve

ISO9906 Annex A 2850rpm

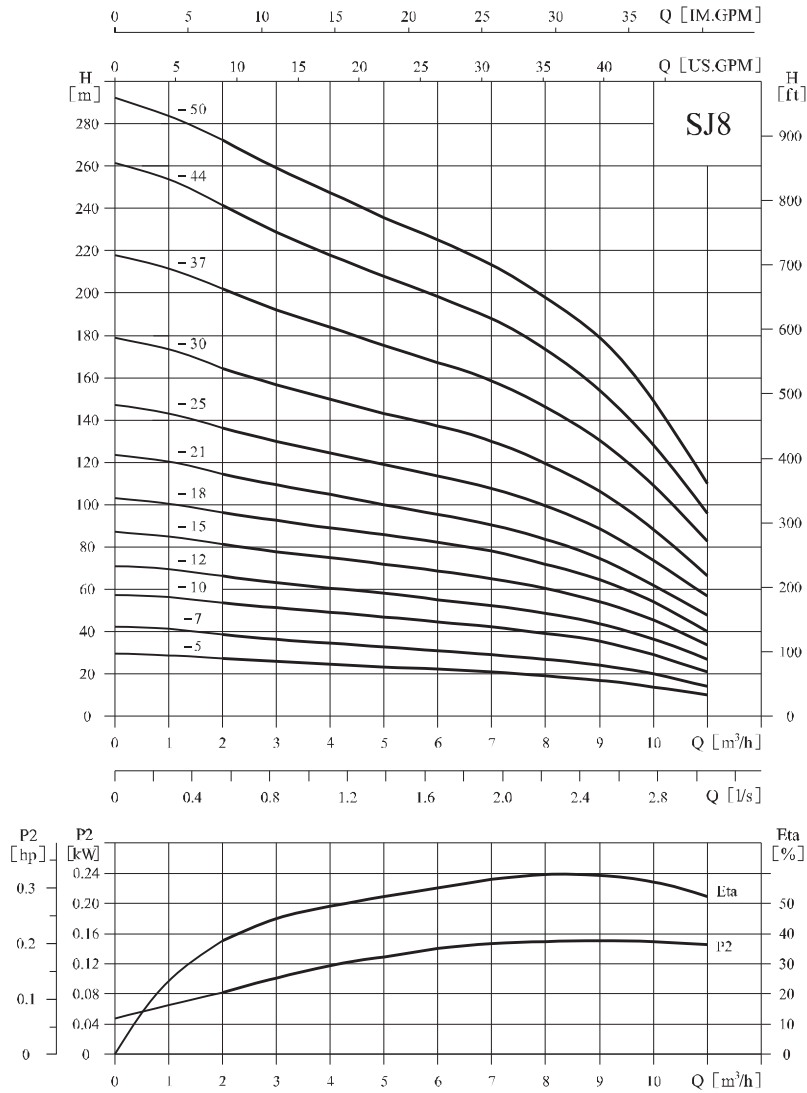

## Performance table

Model	Driving motor		Q (m³/h)	2	3	4	5	6	7	8	9	10	11
	(kW)	(hp)											
SJ8-5	0.75	1	H (m)	27	26	24	23	22	21	19	17	14	10
SJ8-7	1.1	1.5		38	36	34	33	31	29	27	24	20	14
SJ8-10	1.5	2		54	52	50	47	45	42	39	35	29	21
SJ8-12	2.2	3		65	62	60	57	54	51	47	42	35	26
SJ8-15	2.2	3		81	77	74	71	68	64	59	53	44	33
SJ8-18	3.0	4		95	93	89	86	81	77	71	63	53	40
SJ8-21	4.0	5.5		112	108	104	100	95	90	83	74	62	47
SJ8-25	4.0	5.5		135	129	124	119	113	108	99	89	74	56
SJ8-30	5.5	7.5		162	155	149	143	136	130	119	106	88	67
SJ8-37	5.5	7.5		201	191	184	176	167	159	147	131	109	82
SJ8-44	7.5	10		242	227	218	209	199	190	174	156	129	98
SJ8-50	7.5	10	272	258	248	238	226	216	198	177	147	111	

## Installation sketch

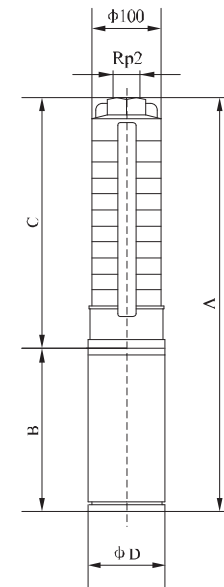

## Size and weight

Model	Size(mm)(Coupled to 4/6' motor)				Weight (kg)
	A	B	C	φD	
SJ8-5	853	400	453	96	15
SJ8-7	977	440	537	96	16
SJ8-10	1133	470	663	96	19
SJ8-12	1257	510	747	96	23
SJ8-15	1383	510	873	96	25
SJ8-18	1619	620	999	96	30
SJ8-21	1907	782	1125	96/143	35/62
SJ8-25	2075	782	1293	96/143	37/64
SJ8-30	2343	840	1503	96/143	45/66
SJ8-37	2637	840	1797	96/143	49/70
SJ8-44	3011	920	2091	96/143	59/77
SJ8-50	3263	920	2343	96/143	62/80

Note: The size B is varied with the motors of different manufacturers.

## Performance curve

ISO9906 Annex A 2850rpm

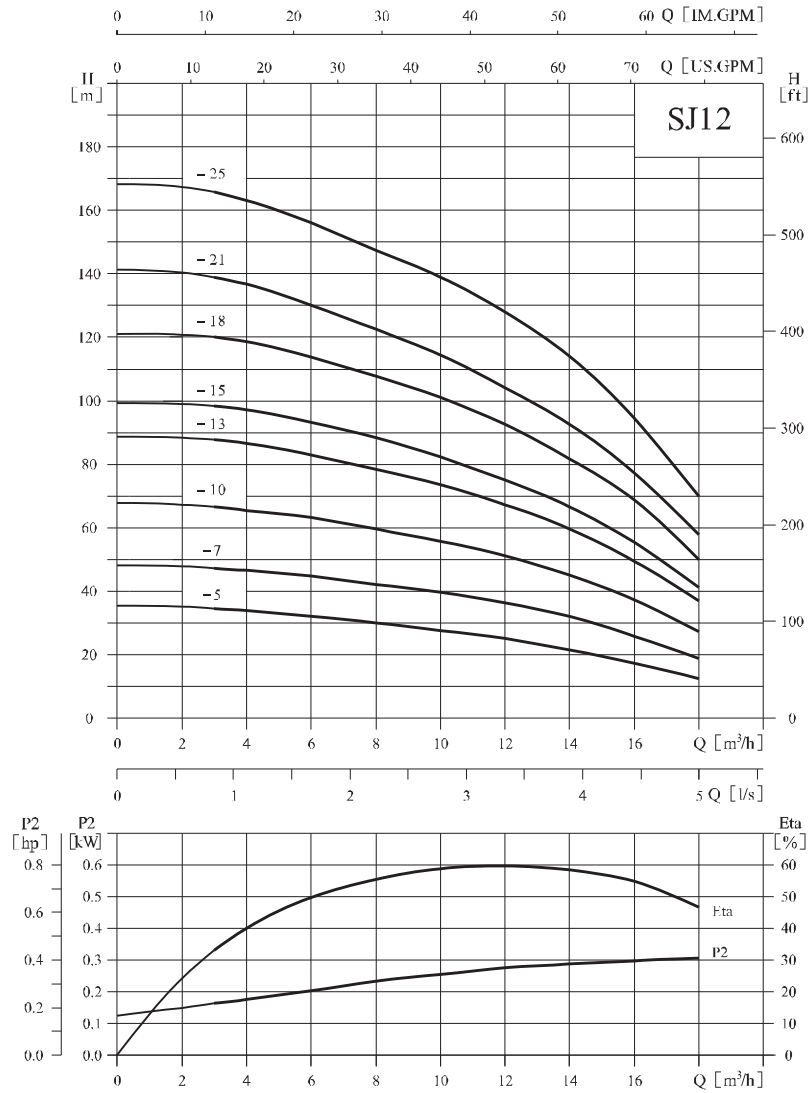

## Performance table

Model	Driving motor		Q (m³/h)	3	4	6	8	10	12	14	16	18
	(kW)	(hp)										
SJ12-5	1.5	2	H (m)	34	33	31	29	27	25	22	18	13
SJ12-7	2.2	3		48	46	43	40	38	35	31	25	19
SJ12-10	3.0	4		67	65	62	58	55	50	45	36	27
SJ12-13	4.0	5.5		88	86	81	76	71	66	59	48	36
SJ12-15	5.5	7.5		99	97	93	88	82	76	68	55	41
SJ12-18	5.5	7.5		120	118	112	105	99	91	81	66	50
SJ12-21	7.5	10		138	136	130	123	115	106	95	77	58
SJ12-25	7.5	10		166	163	155	146	137	126	113	92	69

## Installation sketch

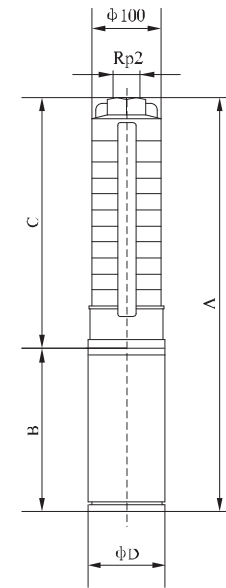

## Size and weight

Model	Size(mm)(Coupled to 4/6' motor)				Weight (kg)
	A	B	C	φD	
SJ12-5	1005	470	535	96	15
SJ12-7	1175	510	665	96	21
SJ12-10	1480	620	860	96	27
SJ12-13	1837	782	1055	96/143	33/60
SJ12-15	2025	840	1185	96/143	40/62
SJ12-18	2220	840	1380	96/143	43/65
SJ12-21	2495	920	1575	96/143	53/71
SJ12-25	2755	920	1835	96/143	57/75

Note: The size B is varied with the motors of different manufacturers.

## Performance curve

ISO9906 Annex A 2850rpm

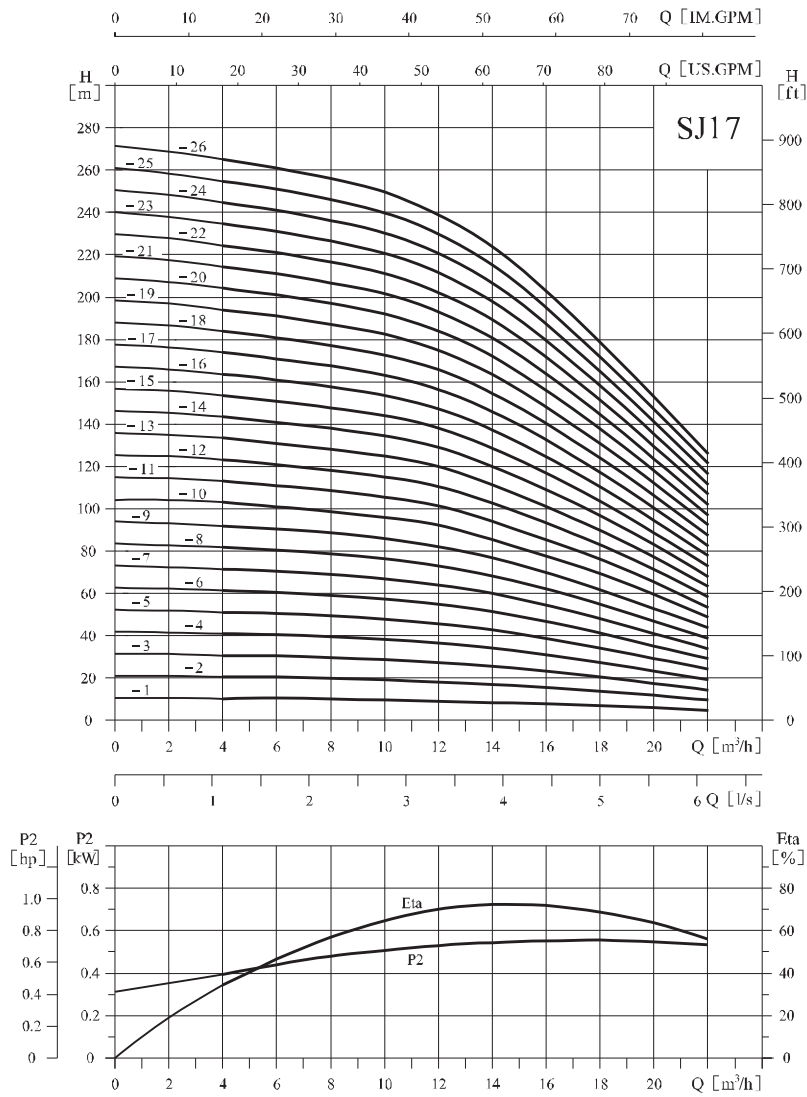

## Performance table

Model	Driving motor		Q (m³/h)	4	6	8	10	12	14	17	20	22
	(kW)	(hp)										
SJ17-1	0.55	0.75	10.5	10	9.5	9	8.5	8	6.5	5	4	
SJ17-2	1.1	1.5	20.5	20	19.5	19	18	16	13.5	10.5	8	
SJ17-3	2.2	3	31	30	29.5	28.5	27	24.5	20.5	16	13	
SJ17-4	2.2	3	41	40	39.5	38	36.5	33.5	28	22	18	
SJ17-5	3.0	4	52	51	50	48	45	42	35	28	23	
SJ17-6	4.0	5.5	62	61	60	58	55	51	42	34	27	
SJ17-7	4.0	5.5	73	71	70	67	64	59	49	40	31	
SJ17-8	5.5	7.5	83	81	80	77	73	67	57	45	36	
SJ17-9	5.5	7.5	93	91	90	87	82	76	64	52	40	
SJ17-10	5.5	7.5	103	101	100	97	91	85	72	58	45	
SJ17-11	7.5	10	113	111	109	106	100	94	79	64	50	
SJ17-12	7.5	10	123	121	119	115	109	102	87	70	55	
SJ17-13	7.5	10	133	131	129	125	118	111	95	75	60	
SJ17-14	9.2	12.5	143	141	139	134	128	119	102	81	65	
SJ17-15	9.2	12.5	153	151	148	144	137	128	109	87	70	
SJ17-16	9.2	12.5	163	161	158	154	146	136	116	92	75	
SJ17-17	9.2	12.5	173	171	167	163	155	145	123	98	79	
SJ17-18	11	15	184	181	177	173	164	154	130	104	84	
SJ17-19	11	15	194	191	187	182	174	162	138	110	89	
SJ17-20	11	15	204	201	197	192	184	171	145	116	94	
SJ17-21	13	17.5	214	211	207	202	193	180	152	121	99	
SJ17-22	13	17.5	224	221	217	211	202	188	160	127	104	
SJ17-23	13	17.5	235	231	227	221	211	197	167	133	109	
SJ17-24	13	17.5	245	241	236	230	220	205	174	139	113	
SJ17-25	15	20	255	251	246	240	229	213	181	145	118	
SJ17-26	15	20	265	261	256	250	238	222	189	150	122	

## Installation sketch

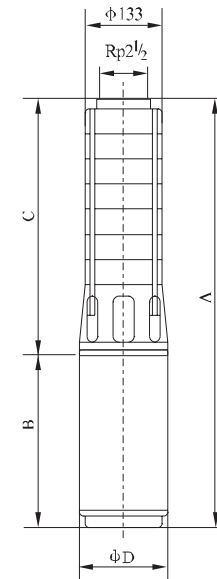

## Size and weight

Model	Size(mm)(Coupled to 4/6' motor)				Weight (kg)
	A	B	C	phi D	
SJ17-1	708	380	328	96	14
SJ17-2	828	440	388	96	18
SJ17-3	959	510	449	96	23
SJ17-4	1019	510	509	96	24
SJ17-5	1190	620	570	96	29
SJ17-6	1412	782	630	96/143	33.58
SJ17-7	1473	782	691	96/143	34.59
SJ17-8	1591	840	751	96/143	40.64
SJ17-9	1652	840	812	96/143	41.65
SJ17-10	1712	840	872	96/143	42.66
SJ17-11	1853	920	933	96/143	50.72
SJ17-12	1913	920	993	96/143	51.73
SJ17-13	1974	920	1054	96/143	52.74
SJ17-14	2027	897	1130	143	79
SJ17-15	2088	897	1191	143	80
SJ17-16	2148	897	1251	143	81
SJ17-17	2209	897	1312	143	82
SJ17-18	2314	942	1372	143	87
SJ17-19	2375	942	1433	143	88
SJ17-20	2435	942	1493	143	89
SJ17-21	2534	980	1554	143	99
SJ17-22	2594	980	1614	143	100
SJ17-23	2655	980	1675	143	101
SJ17-24	2715	980	1735	143	102
SJ17-25	2826	1030	1796	143	103
SJ17-26	2886	1030	1856	143	104

Note: The size B is varied with the motors of different manufacturers.

## Performance curve

ISO9906 Annex A 2850rpm

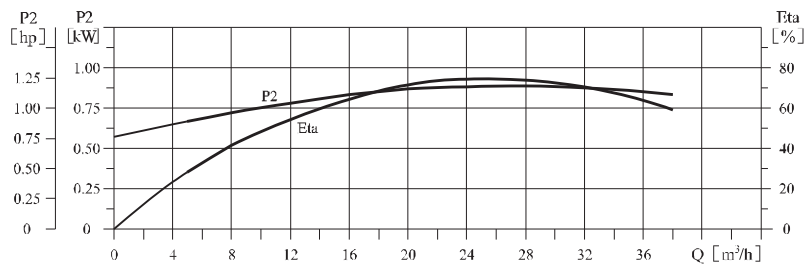
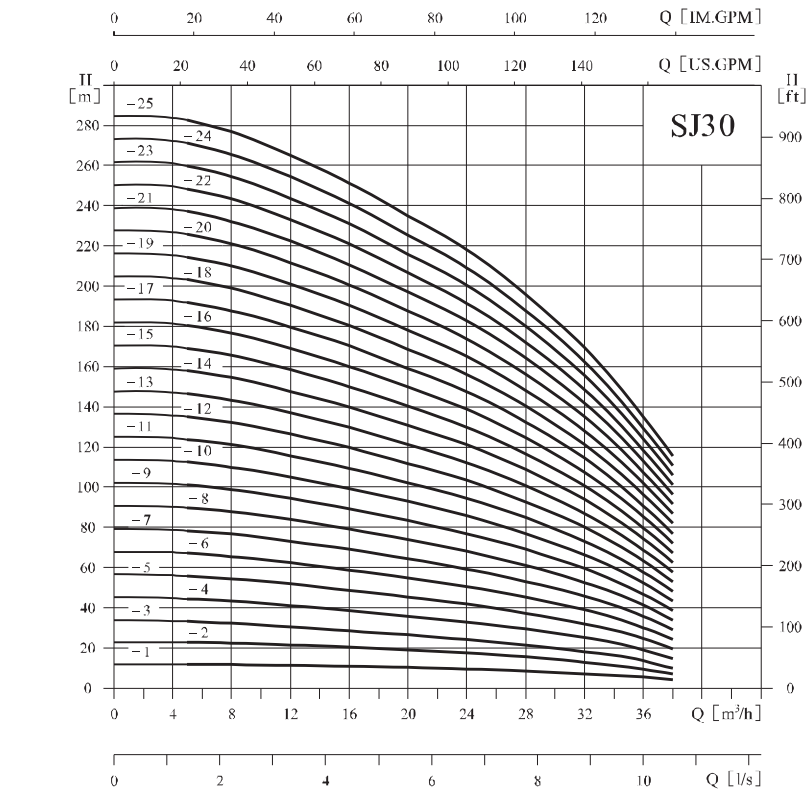

## Performance table

Model	Driving motor		Q (m³/h)	5	8	12	16	20	24	28	30	32	36	38
	(kW)	(hp)												
SJ30-1	1.1	1.5		11.5	11	10.5	10	9.5	9	8	7.5	7	5.5	4.5
SJ30-2	2.2	3		22.5	22	21	20	19	17.5	16	15	14	10.5	9
SJ30-3	3.0	4		33.5	33	32	30	28	26	24	22	20	16	14
SJ30-4	4.0	5.5		44.5	44	42	40	37	35	32	29	27	21	18
SJ30-5	5.5	7.5		55.5	55	53	50	47	44	40	37	34	27	23
SJ30-6	5.5	7.5		67	66	63	60	56	52	48	44	41	32	27
SJ30-7	7.5	10		77	76	74	70	65	61	55	52	48	37	32
SJ30-8	7.5	10		89	87	84	80	75	70	63	59	54	43	36
SJ30-9	9.2	12.5		101	98	95	90	84	78	71	66	61	48	41
SJ30-10	9.2	12.5		112	109	105	100	93	87	79	74	68	53	45
SJ30-11	9.2	12.5		123	120	116	110	103	96	87	81	75	59	50
SJ30-12	11	15		134	131	126	120	112	105	95	88	82	64	54
SJ30-13	11	15		145	142	137	129	121	113	103	96	88	69	59
SJ30-14	13	17.5		157	153	147	139	130	122	111	103	95	74	63
SJ30-15	13	17.5		168	164	158	149	140	131	119	110	102	80	68
SJ30-16	15	20		180	175	168	159	149	140	127	118	109	85	72
SJ30-17	15	20		190	186	179	169	158	148	135	125	116	90	77
SJ30-18	18.5	25		201	197	189	179	168	157	143	132	122	96	81
SJ30-19	18.5	25		212	207	200	189	177	166	150	140	129	101	86
SJ30-20	18.5	25		223	218	210	199	186	174	158	147	136	106	90
SJ30-21	18.5	25		235	229	221	209	196	183	166	155	143	112	95
SJ30-22	22	30		246	240	231	219	205	192	174	162	150	117	99
SJ30-23	22	30		258	251	242	229	214	201	182	169	156	122	104
SJ30-24	22	30		269	262	252	239	224	209	190	177	163	128	108
SJ30-25	22	30		281	273	263	249	233	218	198	184	170	133	113

## Installation sketch

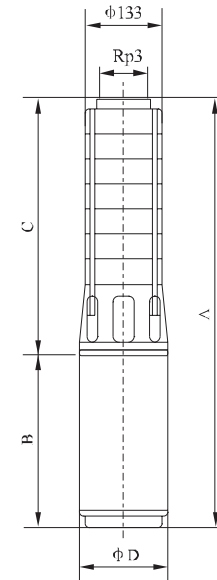

## Size and weight

Model	Size(mm)(Coupled to 4/6' motor)				Weight (kg)
	A	B	C	φ D	
SJ30-1	802	440	362	96	15
SJ30-2	968	510	458	96	21
SJ30-3	1174	620	554	96	27
SJ30-4	1432	782	650	96/143	32/59
SJ30-5	1586	840	746	96/143	39/62
SJ30-6	1682	840	842	96/143	41/64
SJ30-7	1858	920	938	96/143	49/71
SJ30-8	1954	920	1034	96/143	57/73
SJ30-9	2043	897	1146	143	79
SJ30-10	2139	897	1242	143	81
SJ30-11	2235	897	1338	143	83
SJ30-12	2376	942	1434	143	89
SJ30-13	2472	942	1530	143	90
SJ30-14	2606	980	1626	143	101
SJ30-15	2702	980	1722	143	103
SJ30-16	2848	1030	1818	143	105
SJ30-17	2944	1030	1914	143	107
SJ30-18	3100	1090	2010	143	116
SJ30-19	3196	1090	2106	143	118
SJ30-20	3292	1090	2202	143	119
SJ30-21	3388	1090	2298	143	121
SJ30-22	3554	1160	2394	143	128
SJ30-23	3650	1160	2490	143	130
SJ30-24	3746	1160	2586	143	132
SJ30-25	3842	1160	2682	143	134

Note: The size B is varied with the motors of different manufacturers.

## Performance curve

ISO9906 Annex A 2850rpm

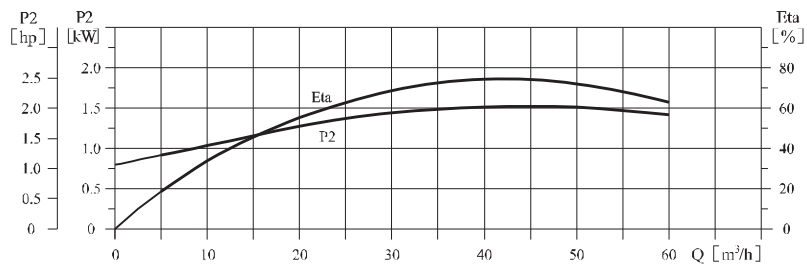
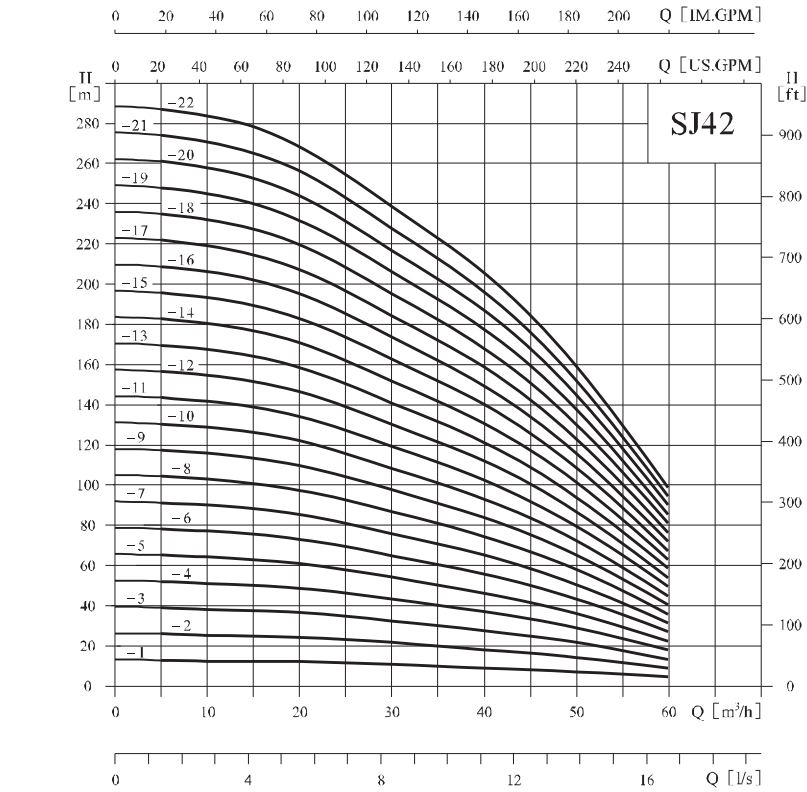

## Performance table

Model	Driving motor		Q (m³/h)	5	10	20	30	40	42	50	60
	(kW)	(hp)									
SJ42-1	2.2	3	13	12.5	12	10.5	9	8.5	7	4	
SJ42-2	3.0	4	26	25.5	24	21.5	18.5	17	14.5	8.5	
SJ42-3	5.5	7.5	40	38.5	36	32.5	28	26.5	22	13	
SJ42-4	7.5	10	53	52	49	43	37	36	29	18	
SJ42-5	7.5	10	66	65	61	54	47	45	38	23	
SJ42-6	9.2	12.5	79	78	74	66	57	54	45	28	
SJ42-7	11	15	92	91	86	77	66	63	52	32	
SJ42-8	13	17.5	105	104	98	87	75	72	58	36	
SJ42-9	15	20	118	117	110	97	84	80	65	40	
SJ42-10	15	20	132	130	122	108	93	89	72	45	
SJ42-11	18.5	25	144	142	134	119	103	98	79	49	
SJ42-12	18.5	25	157	155	146	130	112	107	87	54	
SJ42-13	22	30	170	168	158	141	122	116	94	58	
SJ42-14	22	30	183	181	170	152	131	125	102	63	
SJ42-15	22	30	196	194	182	163	140	134	109	67	
SJ42-16	25	34	209	207	194	174	150	143	116	72	
SJ42-17	25	34	222	220	206	184	159	152	123	77	
SJ42-18	30	40	235	233	218	195	168	161	131	81	
SJ42-19	30	40	248	246	231	206	178	170	138	86	
SJ42-20	30	40	261	259	243	217	187	179	145	90	
SJ42-21	37	50	274	271	255	228	196	188	152	95	
SJ42-22	37	50	287	283	267	238	205	197	160	99	

## Installation sketch

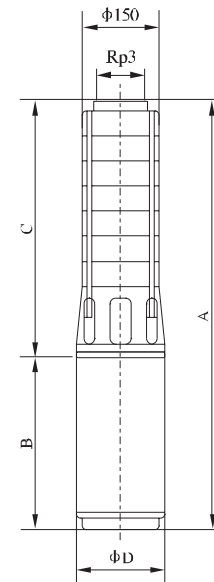

## Size and weight

Model	Size(mm)(Coupled to 4"/6" motor)				Weight (kg)
	A	B	C	Φ D	
SJ42-1	888	510	378	96	20
SJ42-2	1111	620	491	96	27
SJ42-3	1444	840	604	96/143	37/59
SJ42-4	1637	920	717	96/143	46/68
SJ42-5	1750	920	830	96/143	49/71
SJ42-6	1856	897	959	143	77
SJ42-7	2014	942	1072	143	84
SJ42-8	2165	980	1185	143	95
SJ42-9	2328	1030	1298	143	97
SJ42-10	2441	1030	1411	143	100
SJ42-11	2614	1090	1524	143	109
SJ42-12	2727	1090	1637	143	111
SJ42-13	2910	1160	1750	143	119
SJ42-14	3023	1160	1863	143	121
SJ42-15	3136	1160	1976	143	124
SJ42-16	3331	1242	2089	143	135
SJ42-17	3444	1242	2202	143	137
SJ42-18	3697	1382	2315	143	147
SJ42-19	3810	1382	2428	143	149
SJ42-20	3923	1382	2541	143	151
SJ42-21	4224	1570	2654	143	169
SJ42-22	4337	1570	2767	143	171

Note: The size B is varied with the motors of different manufacturers.

## Performance curve

ISO9906 Annex A 2850rpm

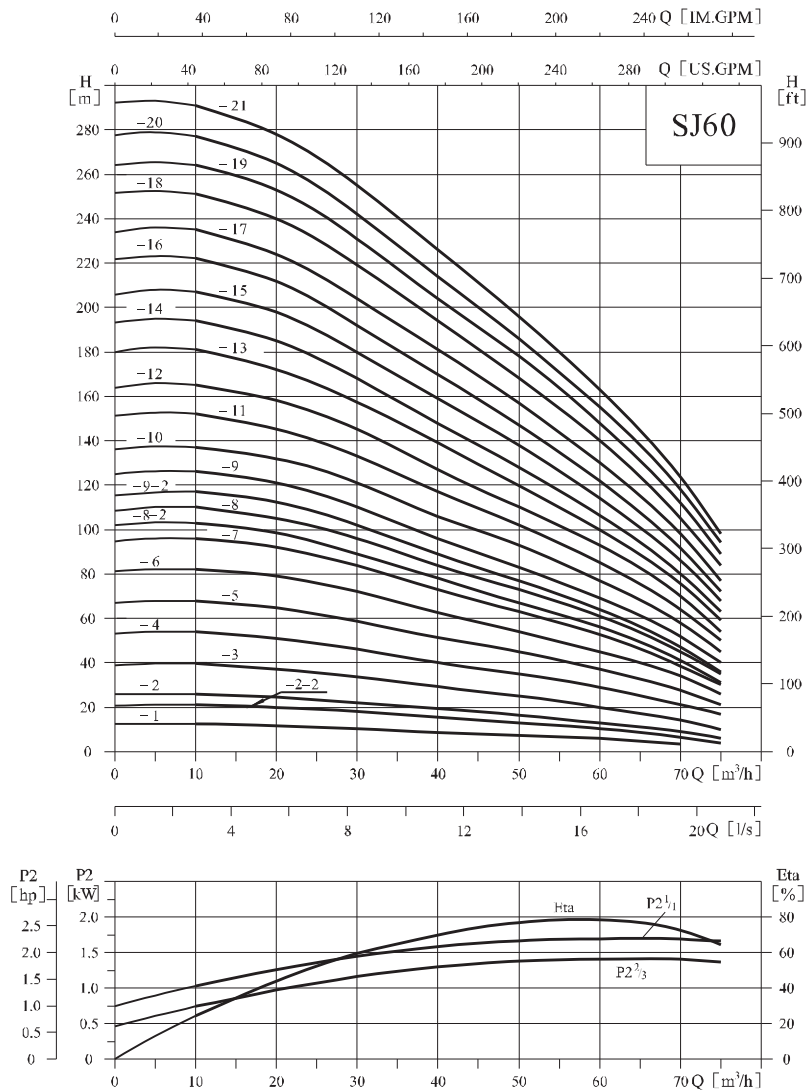

## Performance table

Model	Driving motor		Q (m³/h)	10	20	30	40	50	60	70	75
	(kW)	(hp)									
SJ60-1	2.2	3	12.5	12	10.5	8.5	7	6	4	—	—
SJ60-2-2	3.0	4	21	20	18	15.5	13	10.5	6.5	4	4
SJ60-2	4.0	5.5	26	24.5	22	19	16.5	12.5	9	6	6
SJ60-3	5.5	7.5	40	37	34	29	25	20	14	10	10
SJ60-4	7.5	10	54	51	46	40	35	29	21	17	17
SJ60-5	9.2	12.5	68	65	59	51	45	37	28	21	21
SJ60-6	11	15	82	79	72	62	54	45	34	26	26
SJ60-7	13	17.5	96	92	84	73	63	53	39	30	30
SJ60-8-2	13	17.5	103	99	89	78	67	56	41	31	31
SJ60-8	15	20	110	105	96	84	73	61	45	35	35
SJ60-9-2	15	20	117	112	102	89	77	64	47	36	36
SJ60-9	18.5	25	124	121	110	96	85	69	52	40	40
SJ60-10	18.5	25	137	132	121	106	93	77	58	45	45
SJ60-11	22	30	152	145	133	117	102	85	64	50	50
SJ60-12	22	30	165	158	145	127	110	93	70	54	54
SJ60-13	25	34	181	172	157	139	120	100	75	59	59
SJ60-14	25	34	194	185	168	148	128	106	80	63	63
SJ60-15	25	34	207	198	180	159	138	114	85	68	68
SJ60-16	30	40	222	212	192	170	147	122	91	72	72
SJ60-17	30	40	235	224	204	181	157	130	98	77	77
SJ60-18	37	50	251	240	219	194	168	140	105	84	84
SJ60-19	37	50	264	253	231	204	178	148	112	89	89
SJ60-20	37	50	277	265	242	214	186	155	118	94	94
SJ60-21	37	50	291	278	255	226	196	163	123	98	98

## Installation sketch

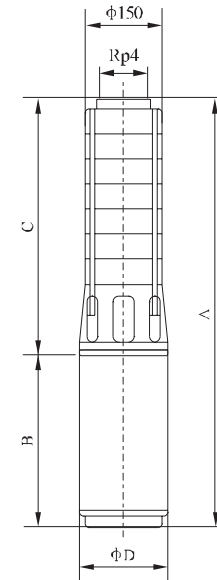

## Size and weight

Model	Size(mm)(Coupled to 4'/6' motor)				Weight (kg)
	A	B	C	$\phi D$	
SJ60-1	878	510	368	96	18
SJ60-2-2	1101	620	481	96	26
SJ60-2	1263	782	481	96/143	29/56
SJ60-3	1434	840	594	96/143	37/59
SJ60-4	1627	920	707	96/143	46/68
SJ60-5	1717	897	820	143	75
SJ60-6	1891	942	949	143	82
SJ60-7	2042	980	1062	143	94
SJ60-8-2	2155	980	1175	143	96
SJ60-8	2205	1030	1175	143	97
SJ60-9-2	2318	1030	1288	143	100
SJ60-9	2378	1090	1288	143	107
SJ60-10	2491	1090	1401	143	110
SJ60-11	2674	1160	1514	143	118
SJ60-12	2787	1160	1627	143	121
SJ60-13	2982	1242	1740	143	133
SJ60-14	3095	1242	1853	143	136
SJ60-15	3208	1242	1966	143	146
SJ60-16	3461	1382	2079	143	149
SJ60-17	3574	1382	2192	143	152
SJ60-18	3875	1570	2305	143	170
SJ60-19	3988	1570	2418	143	173
SJ60-20	4101	1570	2531	143	176
SJ60-21	4214	1570	2644	143	179

Note: The size B is varied with the motors of different manufacturers.

## Performance curve

ISO9906 Annex A 2900rpm

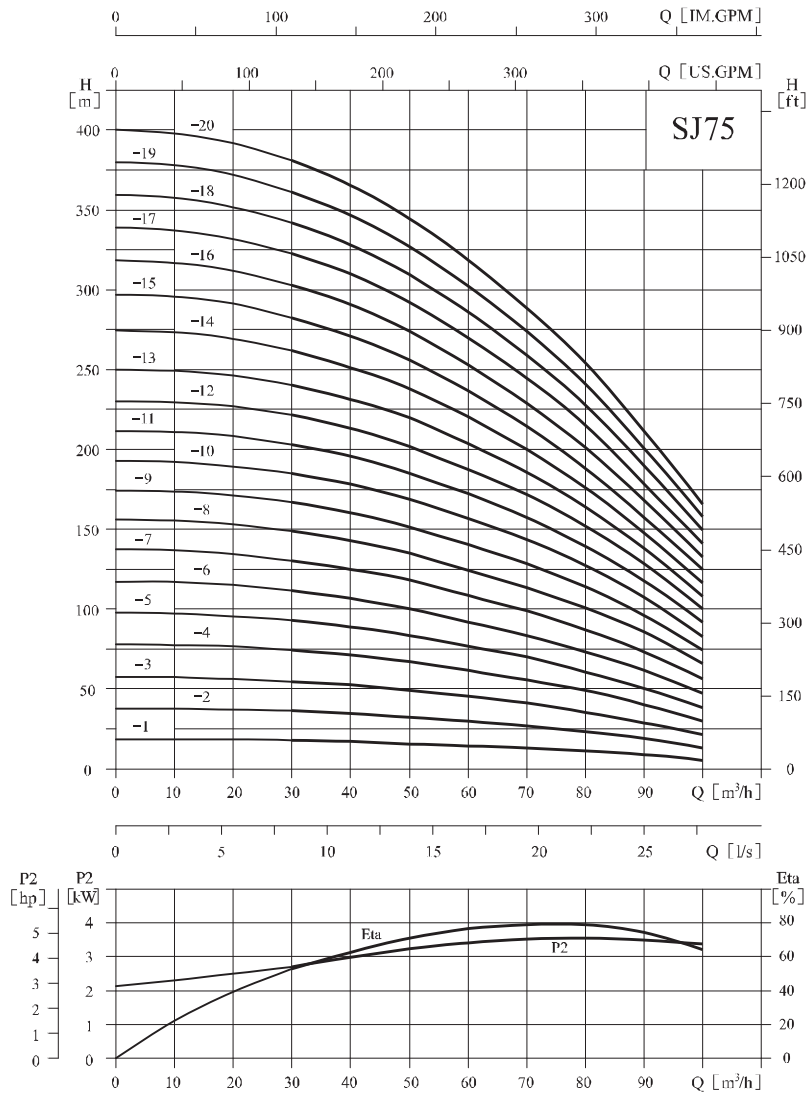

## Performance table

Model	Driving motor		Q (m³/h)	30	40	50	60	70	75	80	90	100
	(kW)	(hp)										
SJ75-1	4	5.5	18	17	15.5	14.5	13	12	11	9	5.5	
SJ75-2	7.5	10	36.5	34.5	32	30	27	25	23	19	12.5	
SJ75-3	11	15	54.5	52.5	49	45	41	38	35.5	29	21.5	
SJ75-4	15	20	73.5	71	66.5	61	55.5	52	48	40	30	
SJ75-5	18.5	25	92	89	83	76	70	65	60.5	51	38	
SJ75-6	22	30	111	107	100	91	84	79	73	62	47	
SJ75-7	30	40	130	125	118	107	98	93	87	73	56	
SJ75-8	30	40	148	143	135	124	113	107	101	85	65	
SJ75-9	37	50	167	161	152	140	128	121	114	96	74	
SJ75-10	37	50	185	178	169	157	143	135	127	107	83	
SJ75-11	45	60	203	196	185	172	158	148	139	118	92	
SJ75-12	45	60	222	214	202	188	172	162	152	129	100	
SJ75-13	55	75	241	232	220	204	186	175	164	139	108	
SJ75-14	55	75	262	251	238	220	200	188	176	149	116	
SJ75-15	55	75	283	271	256	236	214	201	188	159	124	
SJ75-16	63	85	303	291	274	253	229	215	202	169	133	
SJ75-17	63	85	323	310	292	270	245	229	215	179	142	
SJ75-18	75	100	342	329	309	286	259	243	228	190	150	
SJ75-19	75	100	361	347	327	302	274	257	241	201	158	
SJ75-20	75	100	381	366	345	318	288	271	254	212	167	

## Installation sketch

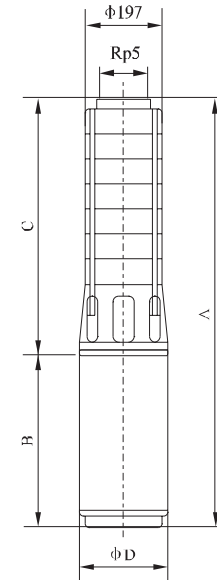

## Size and weight

Model	Size(mm)(Coupled to 6'8" motor)				Weight (kg)
	A	B	C	phi D	
SJ75-1	1270	782	488	143	68
SJ75-2	1476/1421	862/790	614/631	143/184	80/114
SJ75-3	1682/1577	942/820	740/757	143/184	94/125
SJ75-4	1896/1743	1030/860	866/883	143/184	109/137
SJ75-5	2082/1899	1090/890	992/1009	143/184	122/148
SJ75-6	2278/2075	1160/940	1118/1135	143/184	133/166
SJ75-7	2626/2311	1382/1050	1244/1261	143/184	155/193
SJ75-8	2752/2437	1382/1050	1370/1387	143/184	161/199
SJ75-9	3066/2663	1570/1150	1496/1513	143/184	182/226
SJ75-10	3192/2789	1570/1150	1622/1639	143/184	188/232
SJ75-11	3005	1240	1765	184	258
SJ75-12	3131	1240	1891	184	264
SJ75-13	3387	1370	2017	184	302
SJ75-14	3513	1370	2143	184	308
SJ75-15	3639	1370	2269	184	314
SJ75-16	3885	1490	2395	192	333
SJ75-17	4011	1490	2521	192	339
SJ75-18	4187	1540	2647	192	355
SJ75-19	4313	1540	2773	192	361
SJ75-20	4439	1540	2899	192	367

Note: The size B is varied with the motors of different manufacturers.

## Performance curve

ISO9906 Annex A 2900rpm

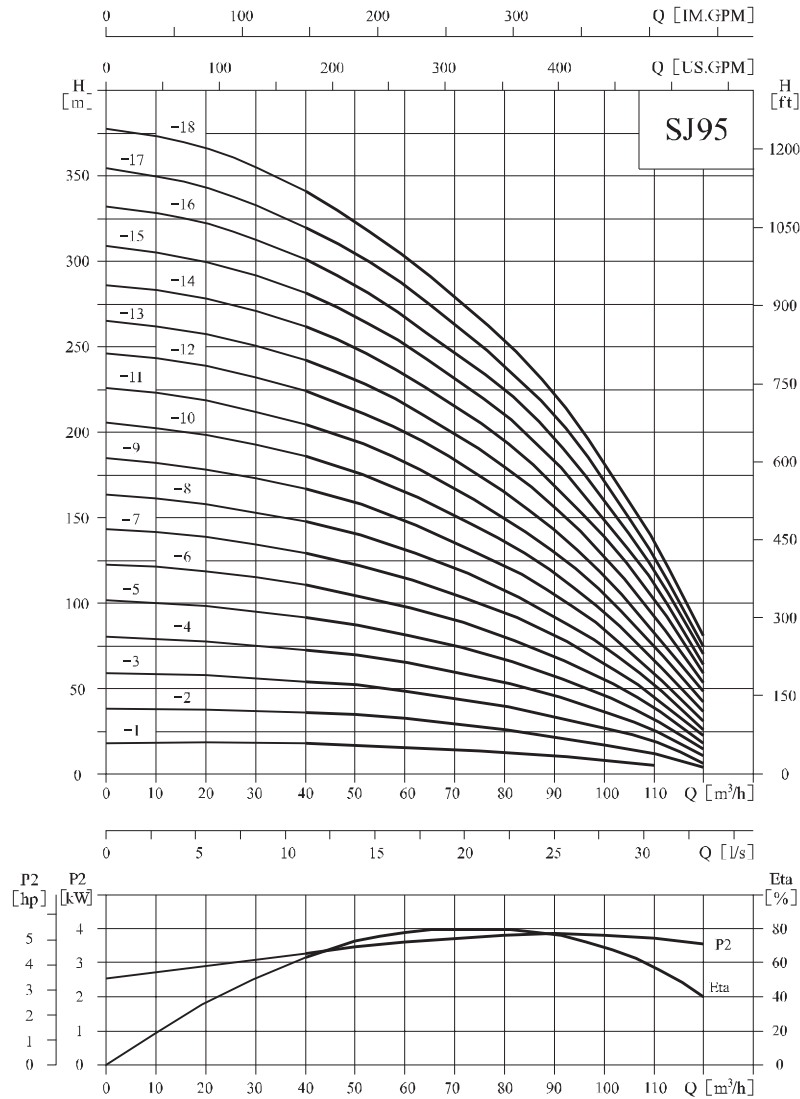

## Performance table

Model	Driving motor		Q (m³/h)	40	50	60	70	80	90	95	100	110	120
	(kW)	(hp)											
SJ95-1	4	5.5	17.5	16.5	15.5	14	12.5	10.5	9.5	8	5	—	—
SJ95-2	9.2	12.5	36	34	32	28.5	26	21.5	20	17	12	12	3.5
SJ95-3	13	17.5	54	52	48.5	44.5	40	33	30	26	19	19	6
SJ95-4	18.5	25	72	70	65	60	54	45	41	36	25.5	25.5	10.5
SJ95-5	22	30	91	87	81.5	75	68	57	51.5	46	32	32	14.5
SJ95-6	25	34	110	104	98	90	81	69	62	55	38	38	18
SJ95-7	30	40	129	122	115	105	94	81	73	65	45	45	22
SJ95-8	37	50	148	141	131	120	108	93	84	75	52	52	26
SJ95-9	37	50	167	159	148	135	122	105	95	85	59	59	31
SJ95-10	45	60	186	177	165	151	136	117	106	95	67	67	36
SJ95-11	45	60	205	195	182	167	150	130	117	105	75	75	42
SJ95-12	55	75	224	213	199	183	165	143	129	116	84	84	48
SJ95-13	55	75	243	231	216	199	180	156	141	127	93	93	53
SJ95-14	55	75	262	249	233	215	195	169	153	138	102	102	59
SJ95-15	63	85	281	268	250	231	210	183	166	149	111	111	64
SJ95-16	63	85	301	286	267	247	225	197	178	160	119	119	70
SJ95-17	75	100	321	304	284	263	240	210	190	171	127	127	75
SJ95-18	75	100	342	323	302	279	255	222	202	182	135	135	81

## Installation sketch

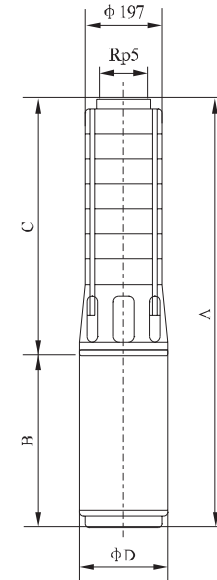

## Size and weight

Model	Size(mm)(Coupled to 6"/8" motor)				Weight (kg)
	A	B	C	$\phi D$	
SJ95-1	1270	782	488	143	68
SJ95-2	1511/1431	897/800	614/631	143/184	84/115
SJ95-3	1720/1617	980/860	740/757	143/184	103/131
SJ95-4	1956/1773	1090/890	866/883	143/184	116/142
SJ95-5	2152/1949	1160/940	992/1009	143/184	127/160
SJ95-6	2360/2125	1242/990	1118/1135	143/184	142/176
SJ95-7	2626/2311	1382/1050	1244/1261	143/184	155/193
SJ95-8	2940/2537	1570/1150	1370/1387	143/184	176/220
SJ95-9	3066/2663	1570/1150	1496/1513	143/184	182/226
SJ95-10	2879	1240	1639	184	252
SJ95-11	3005	1240	1765	184	258
SJ95-12	3261	1370	1891	184	297
SJ95-13	3387	1370	2017	184	302
SJ95-14	3513	1370	2143	184	308
SJ95-15	3759	1490	2269	192	327
SJ95-16	3885	1490	2395	192	333
SJ95-17	4061	1540	2521	192	349
SJ95-18	4187	1540	2647	192	355

Note: The size B is varied with the motors of different manufacturers.

## Performance curve

## ISO9906 Annex A 2900rpm

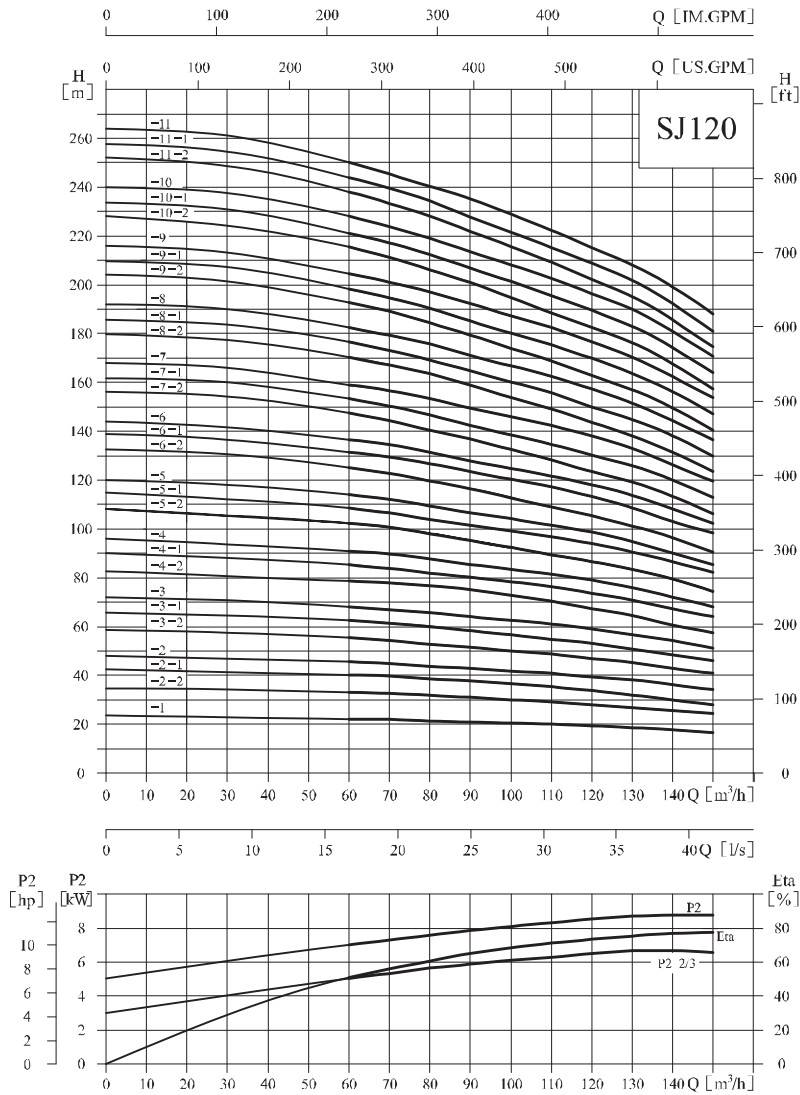

## Performance table

Model	Driving motor		Q (m³/h)	H (m)																Q (m³/h)	Driving motor				
	(kW)	(hp)		60	70	80	90	100	110	120	130	140	150	Model	(kW)	(hp)	60	70	80		90	100	110	120	130
SJ120-1	11	15	22.5	22	21.5	21	20.5	20	19	18.5	17.5	16.5	SJ120-7-2	63	85	147	144	140.5	136.5	132.5	128	123	119	113	106
SJ120-2-2	15	20	33.5	33	32	30	29	28.5	27.5	26.5	24.5	24	SJ120-7-1	63	85	153	150	146.5	142.5	138.5	135	130	125.5	120	112.5
SJ120-2-1	18.5	25	40.5	40	38.5	37.5	36	35.5	33.5	32.5	29.5	28	SJ120-7	75	100	159	156.5	153	149	145	142	138	133	126	119.5
SJ120-2	22	30	45.5	44.5	43.5	42.5	41.5	40.5	39	38	36	34	SJ120-8-2	75	100	170	167	164.5	158	153	148.5	143	138	131.5	123
SJ120-3-2	25	34	55	54.5	52.5	51	49.5	48.5	46.5	45	42.5	40.5	SJ120-8-1	75	100	175.5	173	168.5	163.5	159	155.5	150	145	138	129.5
SJ120-3-1	30	40	62.5	61.5	60	58	56	54	53.5	51	48.5	46	SJ120-8	75	100	181.5	179.5	175	170.5	166	163	157.5	152.5	144	136.5
SJ120-3	30	40	68	67	66.5	64	62	61	59	57	54	51	SJ120-9-2	90	120	192.5	189	184	179.5	174	168.5	162.5	157	149.5	140
SJ120-4-2	37	50	78.5	77	75	72.5	70.5	69	66.5	65	60.5	57.5	SJ120-9-1	90	120	198	195	190.5	185	180	175.5	169.5	164	156	147
SJ120-4-1	37	50	85	84	82	79.5	77	76	73.5	71	67	64	SJ120-9	90	120	204	201.5	198	191.5	186.5	182.5	177.5	171.5	162	153.5
SJ120-4	37	50	90.5	89.5	87.5	85.5	83	81.5	78.5	76	72	68	SJ120-10-2	90	120	215.5	211	206	200.5	194.5	188.5	182.5	176.5	167.5	157.5
SJ120-5-2	45	60	102	100.5	97.5	95	91.5	90	86.5	84	79	74.5	SJ120-10-1	90	120	221	217	212	206.5	200.5	195.5	189.5	183	174	164
SJ120-5-1	45	60	108.5	106.5	103.5	101	98.5	96.5	94	91	86.5	82	SJ120-10	110	150	227	223.5	219	213	207.5	202.5	197	190.5	180	170.5
SJ120-5	55	75	113.5	112	109.5	106.5	103.5	101.5	98.5	95	90	85	SJ120-11-2	110	150	238	233	228	222	215.5	208	202	195.5	185.5	174.5
SJ120-6-2	55	75	125	122.5	119	116.5	112.5	109	104.5	101.5	96	90.5	SJ120-11-1	110	150	243.5	239.5	234	227.5	221.5	215	209	202	192	181
SJ120-6-1	55	75	131	129.5	126.5	123.5	120	117	113	109	103	98	SJ120-11	110	150	250	245.5	241	234.5	228	222.5	216.5	209.5	198.5	187.5
SJ120-6	63	85	136	134.5	131	127.5	124.5	121.5	118	114	108	102													

## Installation sketch

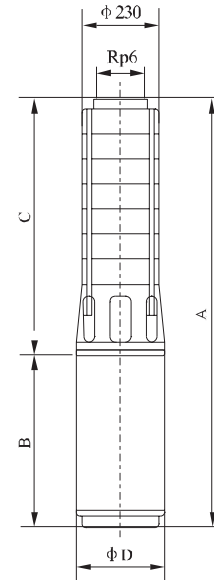

## Size and weight

Model	Size(mm)(Coupled to 6/8/10' motor)				Weight (kg)
	A	B	C	φ D	
SJ120-1	1451/1380--	920/820--	531/560--	144/184--	75/106--
SJ120-2-2	1721/1580--	1030/860--	691/720--	144/184--	92/120--
SJ120-2-1	1781/1610--	1090/890--	691/720--	144/184--	99/125--
SJ120-2	1921/1660--	1230/940--	691/720--	144/184--	104/137--
SJ120-3-2	2093/1870--	1242/990--	851/880--	144/184--	121/155--
SJ120-3-1	2253/1930/2002	1382/1050/1122	851/880/880	144/184/236	128/166/226
SJ120-3	2253/1930/2002	1382/1050/1122	851/880/880	144/184/236	128/166/226
SJ120-4-2	2581/2190/2202	1570/1150/1162	1011/1040/1040	144/184/236	149/194/246
SJ120-4-1	2581/2190/2202	1570/1150/1162	1011/1040/1040	144/184/236	149/194/246
SJ120-4	2581/2190/2202	1570/1150/1162	1011/1040/1040	144/184/236	149/194/246
SJ120-5-2	--2440/2392	--1240/1192	--1200/1200	--184/236	--222/264
SJ120-5-1	--2440/2392	--1240/1192	--1200/1200	--184/236	--222/264
SJ120-5	--2570/2472	--1370/1272	--1200/1200	--184/236	--255/291
SJ120-6-2	--2730/2632	--1370/1272	--1360/1360	--184/236	--263/299
SJ120-6-1	--2730/2632	--1370/1272	--1360/1360	--184/236	--263/299
SJ120-6	--2850/2692	--1490/1332	--1360/1360	--192/236	--276/319
SJ120-7-2	--3010/2852	--1490/1332	--1520/1520	--192/236	--284/327
SJ120-7-1	--3010/2852	--1490/1332	--1520/1520	--192/236	--284/327
SJ120-7	--3060/2942	--1540/1422	--1520/1520	--192/236	--294/357
SJ120-8-2	--3220/3102	--1540/1422	--1680/1680	--192/236	--302/365
SJ120-8-1	--3220/3102	--1540/1422	--1680/1680	--192/236	--302/365
SJ120-8	--3220/3102	--1540/1422	--1680/1680	--192/236	--302/365
SJ120-9-2	--3484/3371	--1644/1531	--1840/1840	--192/236	--328/410
SJ120-9-1	--3484/3371	--1644/1531	--1840/1840	--192/236	--328/410
SJ120-9	--3484/3371	--1644/1531	--1840/1840	--192/236	--328/410
SJ120-10-2	--3644/3531	--1644/1531	--2000/2000	--192/236	--336/418
SJ120-10-1	--3644/3531	--1644/1531	--2000/2000	--192/236	--336/418
SJ120-10	--3764/3641	--1764/1641	--2000/2000	--192/236	--359/455
SJ120-11-2	--3924/3801	--1764/1641	--2160/2160	--192/236	--367/463
SJ120-11-1	--3924/3801	--1764/1641	--2160/2160	--192/236	--367/463
SJ120-11	--3924/3801	--1764/1641	--2160/2160	--192/236	--367/463

Note: The size B is varied with the motors of different manufacturers.

## Performance curve

## ISO9906 Annex A 2900rpm

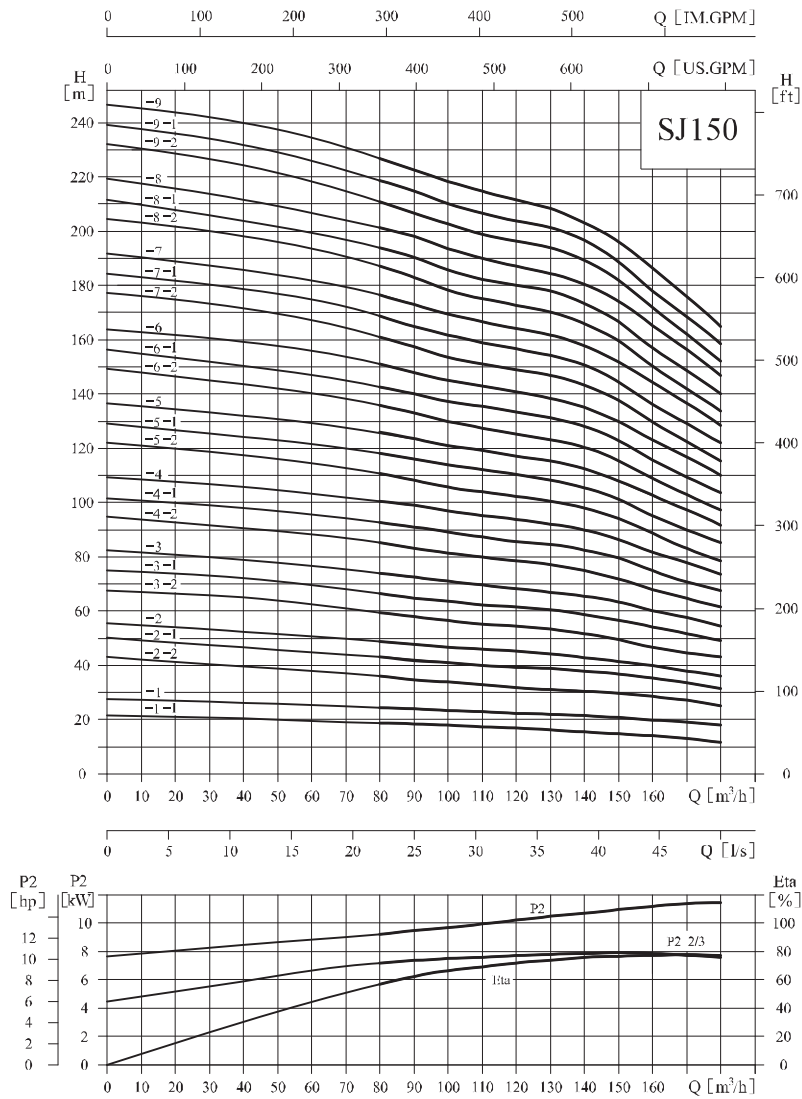

## Performance table

Model	Driving motor		Q (m³/h)	80	90	100	110	120	130	140	150	160	170	180
	(kW)	(hp)												
SJ150-1-1	9.2	12.5	18.5	18	17.5	17	16.5	16	15	14.5	13.5	13	11.5	
SJ150-1	13	17.5	24	23.5	23	22.5	22	21.5	21	20	19.5	19	18	
SJ150-2-2	18.5	25	35.5	34	32	31.5	31	29.5	29	28.5	28	27	25	
SJ150-2-1	22	30	43	41.5	40	39	38.5	38	37.5	36	35.5	34	31	
SJ150-2	25	34	48.5	47.5	46	45	44.5	44	42.5	41	39.5	38	36	
SJ150-3-2	30	40	60	57	54.5	54	53.5	53	52.5	49.5	46.5	44.5	43	
SJ150-3-1	37	50	66.5	64	62.5	61.5	60.5	60	59.5	56.5	54	51.5	49	
SJ150-3	37	50	74.5	72.5	70.5	69.5	68	67.5	65.5	63.5	60	57.5	54.5	
SJ150-4-2	45	60	85.5	83	80	79	77.5	77	76	73	66.5	63.5	61	
SJ150-4-1	45	60	93	90	87.5	86.5	84.5	83.5	83	79.5	73.5	70.5	67	
SJ150-4	55	75	100.5	98	96	94.5	93	92.5	89.5	86.5	80.5	77.5	73	
SJ150-5-2	55	75	111.5	107	104	103	102	101	98	94	86.5	81.5	78.5	
SJ150-5-1	55	75	118.5	114.5	112	110.5	108.5	107	105.5	101	94	89.5	85	
SJ150-5	63	85	126	122.5	120	118	116	115	112.5	108.5	101.5	97	91.5	
SJ150-6-2	63	85	137	131.5	128	126.5	123	122	120.5	115.5	107	101	97	
SJ150-6-1	75	100	144	139	136	134	132	131.5	128	122.5	114.5	109	103.5	
SJ150-6	75	100	151.5	147	144	141.5	139.5	138	135	130	122	116.5	110	
SJ150-7-2	75	100	162.5	156	152.5	150.5	146	145	143	138	128	121	115	
SJ150-7-1	90	120	169.5	163.5	160.5	158	155	153	150.5	145	135.5	129	121.5	
SJ150-7	90	120	177	171.5	168.5	165.5	163.5	162.5	157.5	152.5	143	136.5	128	
SJ150-8-2	90	120	188	180.5	177	174.5	172	171	165.5	160.5	149	140.5	133.5	
SJ150-8-1	110	150	195	188	185	182	180	178.5	173	168.5	156.5	148.5	140	
SJ150-8	110	150	202.5	196	193	189.5	187	186	180	175	164	156	146.5	
SJ150-9-2	110	150	213.5	205	201.5	198	196	194	188.5	182.5	170.5	160	152	
SJ150-9-1	110	150	220.5	212.5	209.5	205.5	203	201.5	196	189.5	178	168	158.5	
SJ150-9	110	150	228	220.5	217.5	213	210	209	203	197	185.5	175.5	165	

## Installation sketch

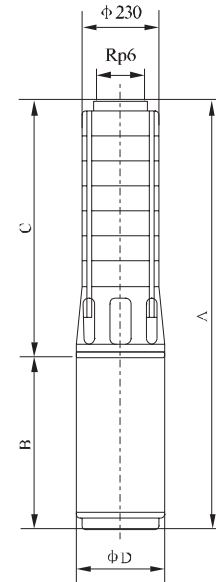

## Size and weight

Model	Size(mm)(Coupled to 6/8/10' motor)				Weight (kg)
	A	B	C	$\phi D$	
SJ150-1-1	1428/1360/--	897/800/--	531/560/--	144/184/--	71/102/--
SJ150-1	1561/1420--	1030/860--	531/560--	144/184/--	84/112/--
SJ150-2-2	1781/1610--	1090/890--	691/720--	144/184/--	99/125/--
SJ150-2-1	1851/1660--	1160/940--	691/720--	144/184/--	104/137/--
SJ150-2	1933/1710/--	1242/990/--	691/720--	144/184/--	113/147/--
SJ150-3-2	2233/1930/2002	1382/1050/1122	851/880/880	144/184/236	128/166/226
SJ150-3-1	2421/2030/2042	1570/1150/1162	851/880/880	144/184/236	142/187/239
SJ150-3	2421/2030/2042	1570/1150/1162	851/880/880	144/184/236	142/187/239
SJ150-4-2	--/2280/2232	--/1240/1192	--/1040/1040	--/184/236	--/214/256
SJ150-4-1	--/2280/2232	--/1240/1192	--/1040/1040	--/184/236	--/214/256
SJ150-4	--/2410/2312	--/1370/1272	--/1040/1040	--/184/236	--/247/283
SJ150-5-2	--/2570/2472	--/1370/1272	--/1200/1200	--/184/236	--/255/291
SJ150-5-1	--/2570/2472	--/1370/1272	--/1200/1200	--/184/236	--/255/291
SJ150-5	--/2690/2532	--/1490/1332	--/1200/1200	--/192/236	--/268/311
SJ150-6-2	--/2850/2692	--/1490/1332	--/1360/1360	--/192/236	--/276/319
SJ150-6-1	--/2900/2782	--/1540/1422	--/1360/1360	--/192/236	--/286/349
SJ150-6	--/2900/2782	--/1540/1422	--/1360/1360	--/192/236	--/286/349
SJ150-7-2	--/3060/2942	--/1540/1422	--/1520/1520	--/192/236	--/294/357
SJ150-7-1	--/3164/3051	--/1644/1531	--/1520/1520	--/192/236	--/312/394
SJ150-7	--/3164/3051	--/1644/1531	--/1520/1520	--/192/236	--/312/394
SJ150-8-2	--/3324/3211	--/1644/1531	--/1680/1680	--/192/236	--/320/402
SJ150-8-1	--/3444/3321	--/1764/1641	--/1680/1680	--/192/236	--/343/439
SJ150-8	--/3444/3321	--/1764/1641	--/1680/1680	--/192/236	--/343/439
SJ150-9-2	--/3604/3481	--/1764/1641	--/1840/1840	--/192/236	--/351/447
SJ150-9-1	--/3604/3481	--/1764/1641	--/1840/1840	--/192/236	--/351/447
SJ150-9	--/3604/3481	--/1764/1641	--/1840/1840	--/192/236	--/351/447

Note: The size B is varied with the motors of different manufacturers.

## Performance curve

ISO9906 Annex A 2900rpm

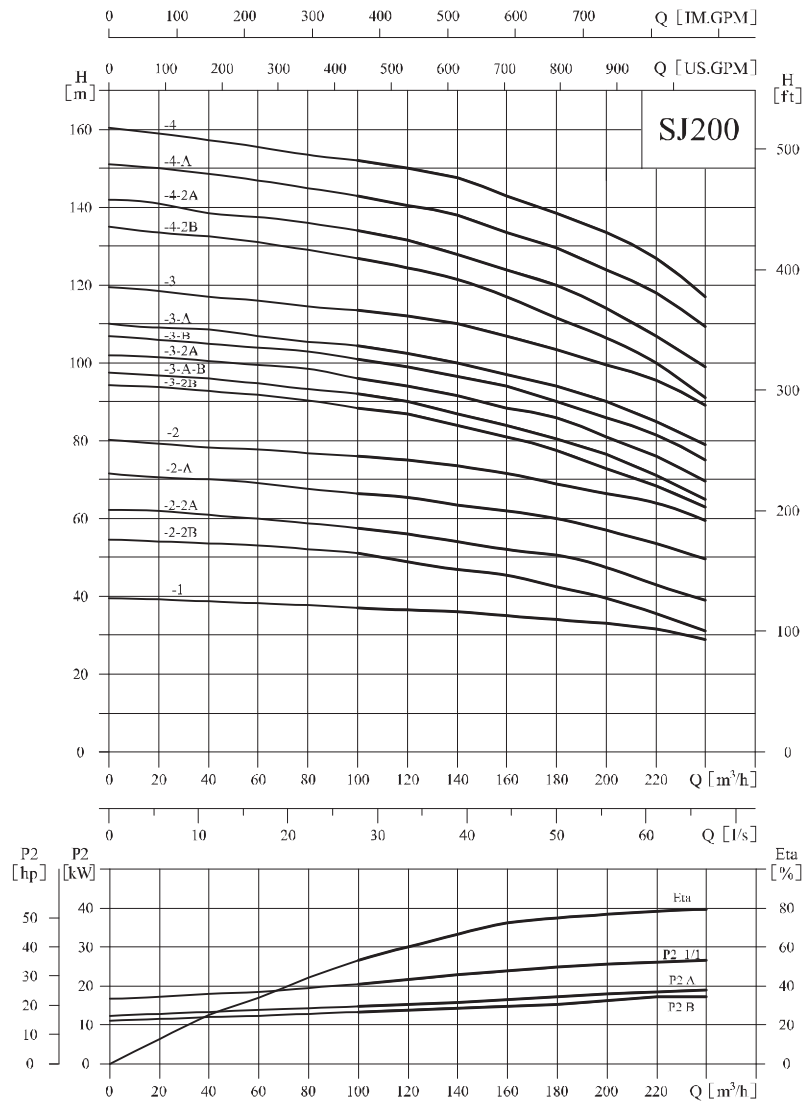

## Performance table

Model	Driving motor		Q (m³/h)	100	120	140	160	180	200	220	240
	(kW)	(hp)									
SJ200-1	30	40	H (m)	37	36.5	36	35	34	33	31.5	29
SJ200-2-2B	37	50		51	49	47	45.5	42.5	39.5	35.5	31
SJ200-2-2A	45	60		57.5	56	54	52	50.5	47.5	43	39
SJ200-2-A	55	75		66.5	65.5	63.5	62	60	57	53.5	49.5
SJ200-2	55	75		76	75	73.5	71.5	69	66.5	64	59.5
SJ200-3-2B	75	100		88.5	87	84	81	78	72.5	68.5	63
SJ200-3-A-B	75	100		92	90	87	84	80.5	76.5	71	65
SJ200-3-2A	75	100		96	94	91.5	88.5	86	81	76	69.5
SJ200-3-B	75	100		101	99	96.5	94	90	86	81.5	109.5
SJ200-3-A	75	100		104.5	102.5	100	97	94	90	85	75
SJ200-3	90	120		113.5	112	110	107	103.5	99.5	95.5	79
SJ200-4-2B	90	120		127	124.5	121.5	117	111.5	106.5	100	89
SJ200-4-2A	110	150	134	131.5	127.5	124	120	114	107	91	
SJ200-4-A	110	150	143	140.5	138	133.5	129.5	124	118	99	
SJ200-4	110	150	152	150	147.5	143	138.5	133.5	127	117	

## Installation sketch

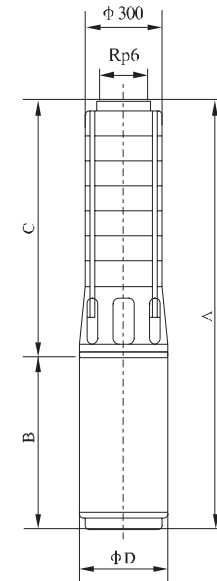

## Size and weight

Model	Size(mm)(Coupled to 10 motor)				Weight (kg)
	A	B	C	$\phi D$	
SJ200-1	1721	1122	599	236	229
SJ200-2-2B	1955	1162	793	236	254
SJ200-2-2A	1985	1192	793	236	264
SJ200-2-A	2065	1272	793	236	291
SJ200-2	2065	1272	793	236	291
SJ200-3-2B	2409	1422	987	236	353
SJ200-3-A-B	2409	1422	987	236	353
SJ200-3-2A	2409	1422	987	236	353
SJ200-3-B	2409	1422	987	236	353
SJ200-3-A	2409	1422	987	236	353
SJ200-3	2519	1532	987	236	390
SJ200-4-2B	2713	1532	1181	236	401
SJ200-4-2A	2823	1642	1181	236	438
SJ200-4-A	2823	1642	1181	236	438
SJ200-4	2823	1642	1181	236	438

Note: The size B is varied with the motors of different manufacturers.